

User Manual

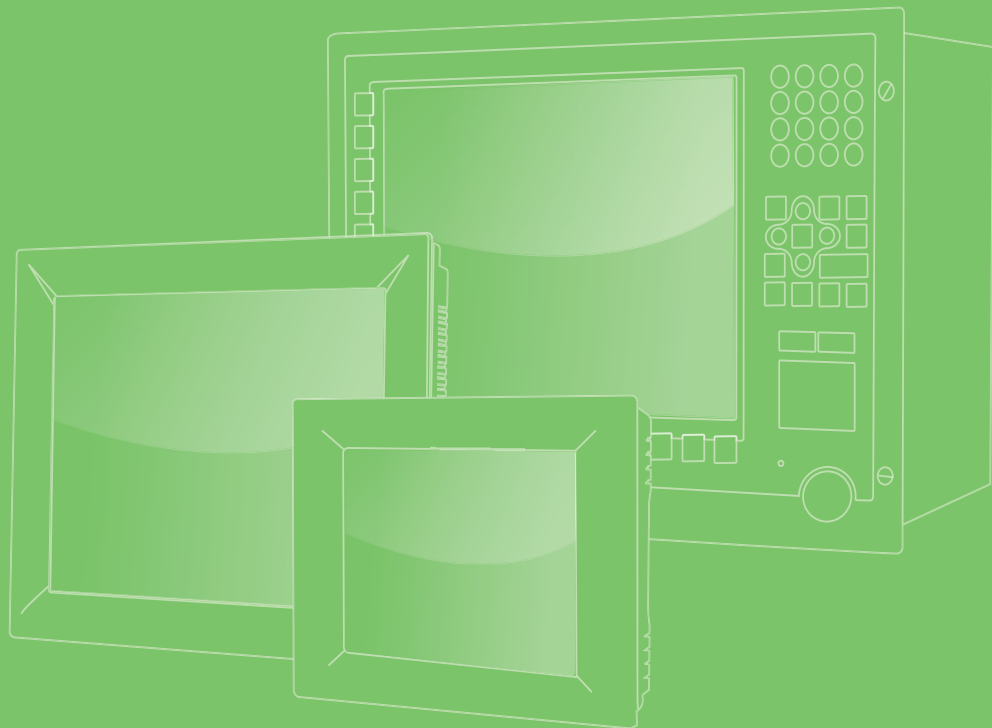

# PPC-6151C/6171C/ 6191C

15"/17"/19" Configurable Panel  
PC Chassis with Selectable Mini-  
ITX Motherboard

**ADVANTECH**

*Enabling an Intelligent Planet*

---

## Copyright

The documentation and software included with this product are copyrighted 2018 by Advantech Co., Ltd. All rights are reserved. Advantech Co., Ltd. reserves the right to improve the products described in this manual at any time without notice. No part of this manual may be reproduced, copied, translated, or transmitted in any form or by any means without the prior written permission of Advantech Co., Ltd. The information provided in this manual is intended to be accurate and reliable. However, Advantech Co., Ltd. assumes no responsibility for its use, nor for any infringements of the rights of third parties that may result from its use.

## Acknowledgements

Intel and Pentium are trademarks of Intel Corporation.

Microsoft Windows is registered trademark of Microsoft Corp.

All other product names or trademarks are properties of their respective owners.

## Product Warranty (2 years)

Advantech warrants the original purchaser that each of its products will be free from defects in materials and workmanship for two years from the date of purchase.

This warranty does not apply to any products that have been repaired or altered by persons other than repair personnel authorized by Advantech, or products that have been subject to misuse, abuse, accident, or improper installation. Advantech assumes no liability under the terms of this warranty as a consequence of such events.

Because of Advantech's high quality-control standards and rigorous testing, most customers never need to use our repair service. If an Advantech product is defective, it will be repaired or replaced at no charge during the warranty period. For out-of-warranty repairs, customers will be billed according to the cost of replacement materials, service time, and freight. Please consult your dealer for more details.

If you think you have a defective product, follow the steps outline below.

1. Collect all the information about the problem encountered (for example, CPU speed, Advantech products used, other hardware and software used, etc.). Note anything abnormal and list any onscreen messages received when the problem occurs.
2. Call your dealer and describe the problem. Please have your manual, product, and any relevant information readily available.
3. If your product is diagnosed as defective, obtain an RMA (return merchandize authorization) number from your dealer. This allows us to process your return more quickly.
4. Carefully pack the defective product, a completed Repair and Replacement Order Card, and a proof of purchase date (such as a photocopy of your sales receipt) into a shippable container. Products returned without a proof of purchase date are not eligible for warranty service.
5. Write the RMA number visibly on the outside of the package, then ship the package prepaid to your dealer.

Part No. 2003C60010

Printed in China

Edition 1

March 2018

# Declaration of Conformity

## CE

This product has passed the CE test for environmental specifications when shielded cables are used for external wiring. We recommend the use of shielded cables. This type of cable is available from Advantech. Please contact your local supplier for ordering information.

## CE

This product has passed the CE test for environmental specifications. Test conditions for passing included the equipment being operated within an industrial enclosure. To protect the product from damage due to electrostatic discharge (ESD) or EMI leakage, we strongly recommend the use of CE-compliant industrial enclosure products.

## FCC Class A

This equipment has been tested and found to comply with the limits for a Class A digital device, pursuant to part 15 of the FCC Rules. These limits are designed to provide reasonable protection against harmful interference when the equipment is operated in a commercial environment. This equipment generates, uses, and can radiate radio frequency energy and, if not installed and used in accordance with the instruction manual, may cause harmful interference to radio communications. Operation of this equipment in a residential area is likely to cause harmful interference, in which case users are required to correct the interference at their own expense.

# Technical Support and Assistance

1. Visit the Advantech website at <http://support.advantech.com> to obtain the latest product information.
2. Contact your distributor, sales representative, or Advantech's customer service center for technical support if you need additional assistance. Please have the following information to hand before calling:
  - Product name and serial number
  - Description of your peripheral attachments
  - Description of your software (operating system, version, application software, etc.)
  - Comprehensive description of the problem
  - The exact wording of any error messages

## Safety Instructions

1. Read these safety instructions carefully.
2. Retain this user manual for future reference.
3. Disconnect the equipment from all AC outlets before cleaning. Use only a damp cloth for cleaning. Do not use liquid or spray detergents.
4. For pluggable equipment, the power outlet socket must be located near the equipment and easily accessible.
5. Protect this equipment from humidity.
6. Place this equipment on a reliable surface during installation. Dropping or letting the equipment fall may cause damage.
7. The openings of the enclosure are for air convection. Protect the equipment from overheating. Do not cover the openings.
8. Ensure that the power source voltage is correct before connecting the equipment to the power outlet.
9. Position the power cord away from high-traffic areas. Do not place anything over the power cord.
10. All cautions and warnings on the equipment should be noted.
11. If not used for a long time, disconnect the equipment from the power source to avoid damage from transient overvoltage.
12. Never pour liquid into an opening. This may cause fire or electrical shock.
13. Never open the equipment. For safety reasons, the equipment should be opened only by qualified service personnel.
14. If one of the following occurs, have the equipment checked by service personnel:
  - The power cord or plug is damaged.
  - Liquid has penetrated into the equipment.
  - The equipment has been exposed to moisture.
  - The equipment is malfunctioning, or does not operate according to the user manual.
  - The equipment has been dropped and damaged.
  - The equipment shows obvious signs of breakage.
15. Do not leave this equipment in an environment with a storage temperature of below -30 °C (-22 °F) or above 60 °C (140 °F) as this can cause damage. The equipment should be stored in a controlled environment.
16. Batteries are at risk of exploding if incorrectly replaced. Replace only with the same or equivalent type recommend by the manufacturer. Discard used batteries according to the manufacturer's instructions.  
Danger d'explosion si la batterie est mal remplacée. Remplacer uniquement par le même type ou équivalent recommandé par le fabricant. Jeter les piles usagées selon les instructions du fabricant.

In accordance with IEC 704-1:1982 specifications, the sound pressure level at the operator position does not exceed 70 dB (A).

DISCLAIMER: These instructions are provided according to IEC 704-1. Advantech disclaims all responsibility for the accuracy of any statements contained herein.

**Caution!** *Pour éviter tout risque d'électrocution, ne pas enlever le couvercle. Aucune pièce réparable par l'utilisateur ne se trouve à l'intérieur. Confier tout entretien à un personnel qualifié uniquement.*



## Safety Precautions - Static Electricity

Follow these simple precautions to protect yourself from harm and the products from damage.

- To avoid electrical shock, always disconnect the power from the PC chassis before manual handling. Do not touch any components on the CPU card or other cards while the PC is switched on.
- Disconnect all power before making any configuration changes. A sudden rush of power when connecting a jumper or installing a card may damage sensitive electronic components.

## Power Warning

The power is suitable for areas with an altitude of 5000 M and below.







## Battery Information





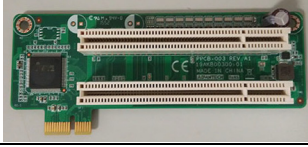





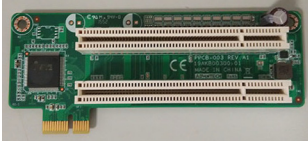

Batteries, battery packs, and accumulators should not be disposed of in unsorted household waste. Please use the public collection system to return, recycle, or treat them in compliance with your local regulations.

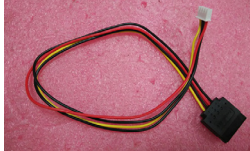

## Initial Inspection

Upon opening the shipping carton, check that the items below are included in the shipment.

Model	Item	Qty	Image
PPC-6151C/6171C/ 6191C-RTAE	Chassis	1	
	Riser card PCIe x4	1	
	Riser card PCI	1	
	User manual	1	
	Warranty card	1	
	HDD screws	4	
	M/B and riser card screws	6	
	Panel bracket and screws	10/12	
	Mini PCIe screw	1	

Model	Item	Qty	Image
PPC-6151C/6171C/ 6191C-RMAE	Chassis	1	
	Riser card PCIe x4	1	
	Riser card PCI	1	
	DP input cable	1	
	USB input cable	1	
	SATA cable	1	
	SATA power cable	1	
	User manual	1	
	Warranty card	1	
	HDD screws	8	
	M/B and riser card screw	6	
	Panel bracket and screws	10/12	
	DC bracket	1	
	DC bracket screws	2	
Mini PCIe screw	1		

---

If any of the aforementioned items are missing or damaged, contact your distributor or sales representative immediately. We have carefully inspected the product mechanically and electrically before shipment. The product should be free of marks and scratches and in perfect working order upon receipt. As you unpack the product, check the equipment for signs of shipping damage (for example, damaged box, scratches, dents, etc.). If the product is damaged or fails to meet the specifications, notify our service department or your local sales representative immediately. Additionally, please notify the carrier. Retain the shipping carton and packing material for inspection by the carrier. After inspection, we will make arrangements to repair or replace the unit.



# Contents

<b>Chapter 1</b>	<b>Introduction.....</b>	<b>1</b>
1.1	Overview .....	2
1.2	Features .....	2
1.3	Chassis Comparison .....	3
1.4	Specifications .....	4
1.4.1	Specifications Comparison .....	4
1.4.2	General Specifications .....	4
1.5	External View .....	5
1.6	System View .....	7
1.7	Dimensions .....	8
	Figure 1.1 PPC-6151C dimensions .....	8
	Figure 1.2 PPC-6171C dimensions .....	9
	Figure 1.3 PPC-6191C dimensions .....	10
<b>Chapter 2</b>	<b>System Installation and Setup .....</b>	<b>11</b>
2.1	Anti-Static Precautions .....	12
2.2	Installation Procedures.....	12
2.3	PPC-6151C/6171C/6191C-RTAE Motherboard Installation .....	13
2.3.1	Remove the Back Cover .....	13
2.3.2	Remove the Reinforced Board.....	13
2.3.3	Check and Adjust Jumpers on the Motherboard.....	14
2.3.4	Install the PPC-MB-8260AE Motherboard .....	16
2.3.5	Connect the Motherboard Wires .....	17
2.4	PPC-6151C/6171C/6191C-RMAE Motherboard Installation.....	18
2.4.1	Remove the Back Cover .....	18
2.4.2	Remove the Reinforced Bracket.....	19
2.4.3	Check Jumper Setting of the Chassis.....	20
2.4.4	Install the Mini-ITX Motherboard (AIMB-275) .....	23
2.4.5	Connect the Motherboard Wires .....	24
2.4.6	Connect the Daughter Board and Motherboard Using a Cable ..	27
2.5	Component Setup .....	28
2.5.1	CPU Installation .....	28
2.5.2	CPU Cooler Installation.....	29
2.5.3	Memory Installation.....	29
2.5.4	HDD Installation .....	31
2.5.5	Wi-Fi Module Installation.....	32
2.5.6	Expansion Card Installation .....	35
2.5.7	Rear Cover Installation .....	36
2.6	Mount Installation .....	37
2.7	Quick Installation.....	38
<b>Chapter 3</b>	<b>System Maintenance .....</b>	<b>41</b>
3.1	Introduction .....	42
3.2	AC Power Supply Replacement.....	42
3.3	Daughter Board Replacement.....	43
3.4	System Fan Replacement.....	44
3.5	LCD and Touch Panel Replacement.....	45
<b>Appendix A</b>	<b>PCI/PCIE Riser Card .....</b>	<b>47</b>

A.1	Riser Card Introduction.....	48
A.1.1	PPCB-003 PCI Riser Card.....	48
A.1.2	PPCB-006 PCIE x4 Riser Card .....	48
A.1.3	EAMB-BE02 2 x PCIe x 1 Riser Card.....	49
A.1.4	EAMB-BE03 1 x PCIe x 1+1 x PCI Riser Card.....	50
<b>Appendix B</b>	<b>BSMI ROHS.....</b>	<b>51</b>
B.1	BSMI ROHS.....	52
B.2	BSMI 警語及注意事項.....	52
<b>Appendix C</b>	<b>China ROHS.....</b>	<b>53</b>
C.1	China ROHS .....	54

# Chapter 1

## Introduction

- Overview
- Features
- Chassis Comparison
- Specifications
- External View
- System View
- Dimensions

---

## 1.1 Overview

The PPC-6151C/6171C/6191C is a panel PC chassis developed for Mini-ITX motherboards and equipped with a 15"/17"/19" TFT LED panel. PPC-6151C/6171C/6191C supports many Mini-ITX motherboards to satisfy diverse customer requirements regarding price and functionality.

PPC-6151C/6171C/6191C also features a true flat bezel to meet market demands for a stylish design, as well as an additional reservation port and expansion slot to accommodate various applications. The PPC-6151C/6171C/6191C series devices were developed in keeping with two design concepts - optimization and compatibility. Optimization allows the devices to be equipped with a motherboard designed by Advantech's PPC team, while compatibility allows the devices to support diverse Mini-ITX form factor motherboards.

## 1.2 Features

- 15"/17"/19" true-flat PPC with resistive touch
- Supports certified Mini-ITX motherboards, up to 45 W TDP processor
- Supports one PCI/PCIe expansion slot
- Front-facing LED indicators for power status
- Front panel is IP65 compliant
- Optional VESA mount available upon request

## 1.3 Chassis Comparison

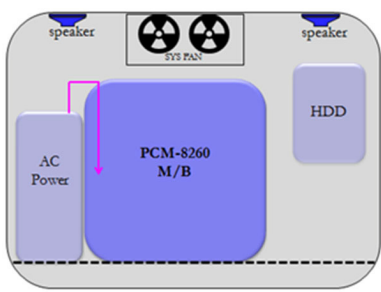
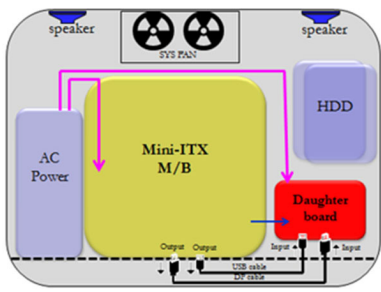
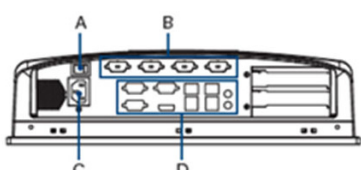
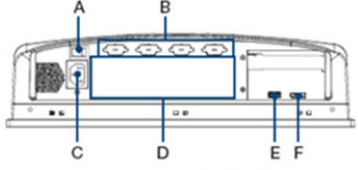
Chassis P/N	PPC-6151C/6171C/6191C-RTAE	PPC-6151C/6171C/6191C-RMAE
Design Goal	Highly optimized	Highly compatible
Supported Motherboard Type	Must follow design guide	Compatible with most Mini-ITX motherboards certified by Advantech
Daughter Board	Unnecessary	Necessary (additional cabling for external USB and DP)
Riser Card	2 slots	1 slot
HDD Kit	1	2
Speaker	2 x 1W	Optional
Advantage	1. Reduced cabling 2. Cost effective (w/o daughter board)	1. Compatible with most Mini-ITX motherboards
Internal Box Structure		
I/O View	 A. Power Switch      C. AC inlet B. Reservation port      D. PPC-MB-8260AE I/O port	 A. Power Switch      E. USB2.0 (input, for connecting M/B and touch controller) B. Reservation port      F. Display port (input, for connecting M/B and touch controller) C. AC inlet D. Mini-ITX M/B I/O port

**Note!**  Users can determine which chassis they are using by checking whether the system features a USB port and a DP port. After identifying the chassis type, refer to Chapters 2.3 and 2.4 (PPC-6151C/6171C/6191C-RTAE and PPC-6151C/6171C/6191C-RMAE, respectively) for installation.

**Note!**  When selecting a motherboard, please refer to the PPC-6151C/6171C/6191C selection guide.

## 1.4 Specifications

### 1.4.1 Specifications Comparison

Product	PPC-6151C-RTAE/ RMAE	PPC-6171C-RTAE/ RMAE	PPC-6191C-RTAE/ RMAE
LCD	15" LCD	17" LCD	19" LCD
Display Type	15" TFT LCD (with LED backlight)	17" TFT LCD (with LED backlight)	19" TFT LCD (with LED backlight)
Max. Resolution	1024 x 768	1280 x 1024	1280 x 1024
Dot Matrix	0.297 x 0.297 mm	0.264 x 0.264 mm	0.294 x 0.294 mm
Viewing Angle	80 (left), 80 (right) 70 (top), 70 (bottom)	80 (left), 80 (right) 60 (top), 80 (bottom)	85 (left), 85 (right) 80 (top), 80 (bottom)
Brightness	400 cd/m2	350 cd/m2	350 cd/m2
Contrast	700	800	1000
Weight	5.03 kg (11.08 lb)	5.4 kg (11.9 lb)	5.8 kg (12.8 lb)
Dimensions	391.4 x 312.5 x 103.6 mm (15.4 x 12.3 x 4.08 in)	437 x 357 x 107.6 mm (17.2 x 14.06 x 4.2 in)	454 x 379.8 x 107.5 mm (17.9 x 15 x 4.2 in)

### 1.4.2 General Specifications

		PPC6151C/6171C/6191C- RTAE	PPC-6151C/6171C/6191C- RMAE	
		Storage	1 x 2.5" SATA bay	2 x 2.5" SATA bay
Chassis Features	I/O	2 x WLAN antenna ports		
		1 x AC jack 1 x Power switch 1 x VGA 1 x DP* 1 x DIO 4 x RS232 1 x RS232/422/485 2 x LAN 4 x USB 3.0 1 x Line-Out 1 x Mic-In	4 x Reserved connectors (DB9) 1 x AC jack 1 x Power switch 1 x DP* 1 x USB 2.0**	
		Expansion	Reserved ports: According to motherboard specifications	
		Either 1 x PCIe x4 or 2 x PCI (in the accessory box)	Either 1 x PCIe x4 or 1 x PCI (in the accessory box)	
		Speaker	2 x 1W	2 x 1W (optional)
		Fan	2 x 12 V (60 x 60 x 15 mm/)	
OS Support	OS Support	Based on motherboard specifications		
Power Consumption	Input Voltage	100 ~ 240 VAC, 250 W		
LCD	Backlight Lifetime	50,000 hours minimum		
Touchscreen	Touch Type	Analog resistive 5-wire/projected capacitive (optional)		
	Light Transmission	80+/-5%		
	Controller	USB interface		
	Durability	35 million touches		

Environment	Operating Temperature	0 ~ 50 °C (32 ~ 122 °F)
	Storage Temperature	-30 ~ 60 °C (-22 ~ 140 °F)
	Relative Humidity	10 ~ 95% @ 40 °C (non-condensing)
	Shock	Operating 10 G peak acceleration (11 ms duration), follows IEC 60068-2-27
	Vibration	Operating random vibration test 5 ~ 500Hz, 1Grms @with HDD, follows IEC 60068-2-64
	EMC	CE, FCC Class A
	Front Panel Protection	IP65 compliant

**Note!** \*1 x DP (for connecting the motherboard and LVDS panel)



\*\*1 x USB 2.0 (for connecting the motherboard and touch controller)

## 1.5 External View

The front of PPC-6151C/6171C/6191C is a flat panel LCD screen enclosed in an aluminium frame. (When placed upright on a desk, the PPC-6151C/6171C/6191C front panel appears as shown below.)



PPC-6151C/6171C/6191C-RTAE Off (S3, S4, S5): orange; On (S0): blue

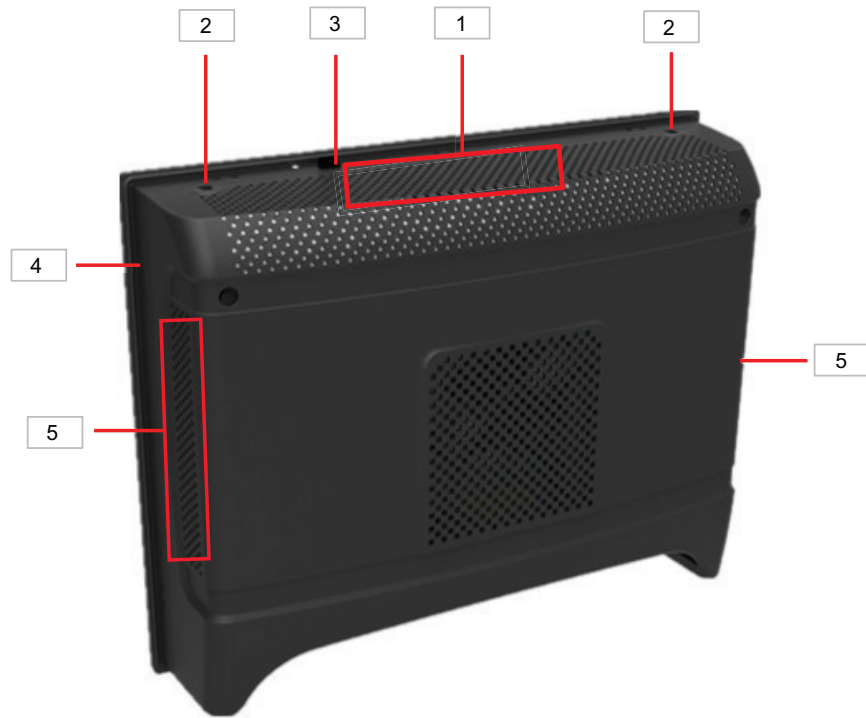

PPC-6151C/6171C/6191C-RMAE Off (S3, S4, S5): orange or off; On (S0): blue



1. Air outlets
2. Antenna holes
3. Quick installation clip (1)
4. Panel mount bracket holes (10 for PPC-6151C/6171C and 12 for PPC-6191C)
5. Air inlets

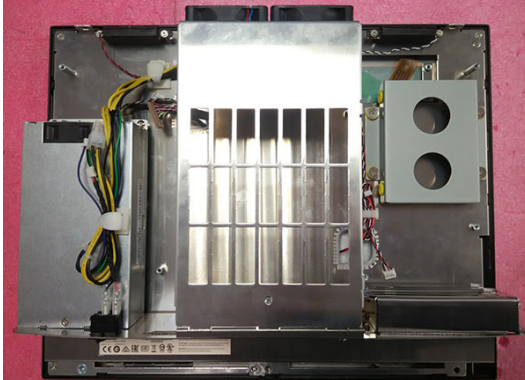
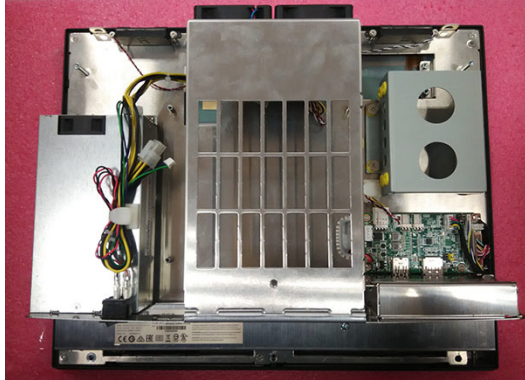

## 1.6 System View

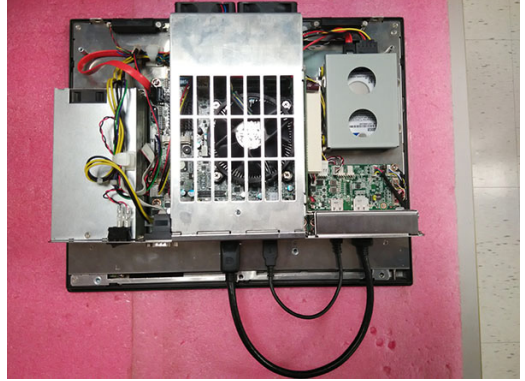
<p>PPC-6151C/6171C/6191C-RTAE barebone chassis</p>	<p>PPC-6151C/6171C/6191C-RMAE barebone chassis</p>
 <p>A photograph of the PPC-6151C/6171C/6191C-RTAE barebone chassis. It is a metal enclosure with a central vertical slot for a motherboard. The front panel is partially open, revealing internal components like the power supply and cooling fans. The chassis is mounted on a base with feet.</p>	 <p>A photograph of the PPC-6151C/6171C/6191C-RMAE barebone chassis. It is similar to the RTAE version but has a different internal layout for the motherboard and components. The front panel is also partially open, showing the internal hardware.</p>
<p>With a PPC-MB-8260AE motherboard</p>	<p>With an AIMB-275G motherboard</p>
 <p>A photograph showing the PPC-6151C/6171C/6191C-RTAE chassis with a PPC-MB-8260AE motherboard installed. The motherboard is seated in the central slot, and its components are visible through the front panel's mesh.</p>	 <p>A photograph showing the PPC-6151C/6171C/6191C-RMAE chassis with an AIMB-275G motherboard installed. The motherboard is seated in the central slot, and its components are visible through the front panel's mesh. The chassis is shown from a slightly different angle than the previous images.</p>

## 1.7 Dimensions

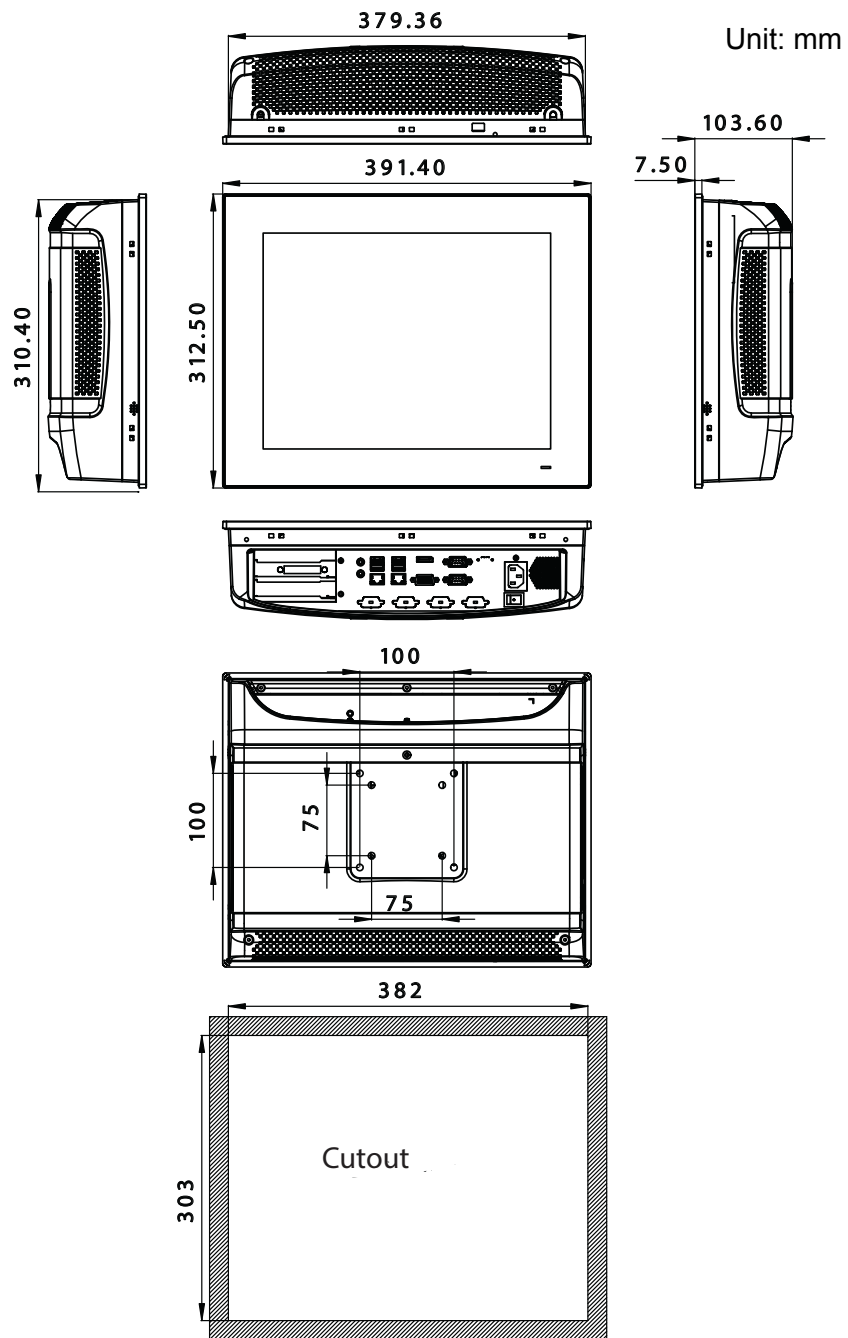

Figure 1.1 PPC-6151C dimensions

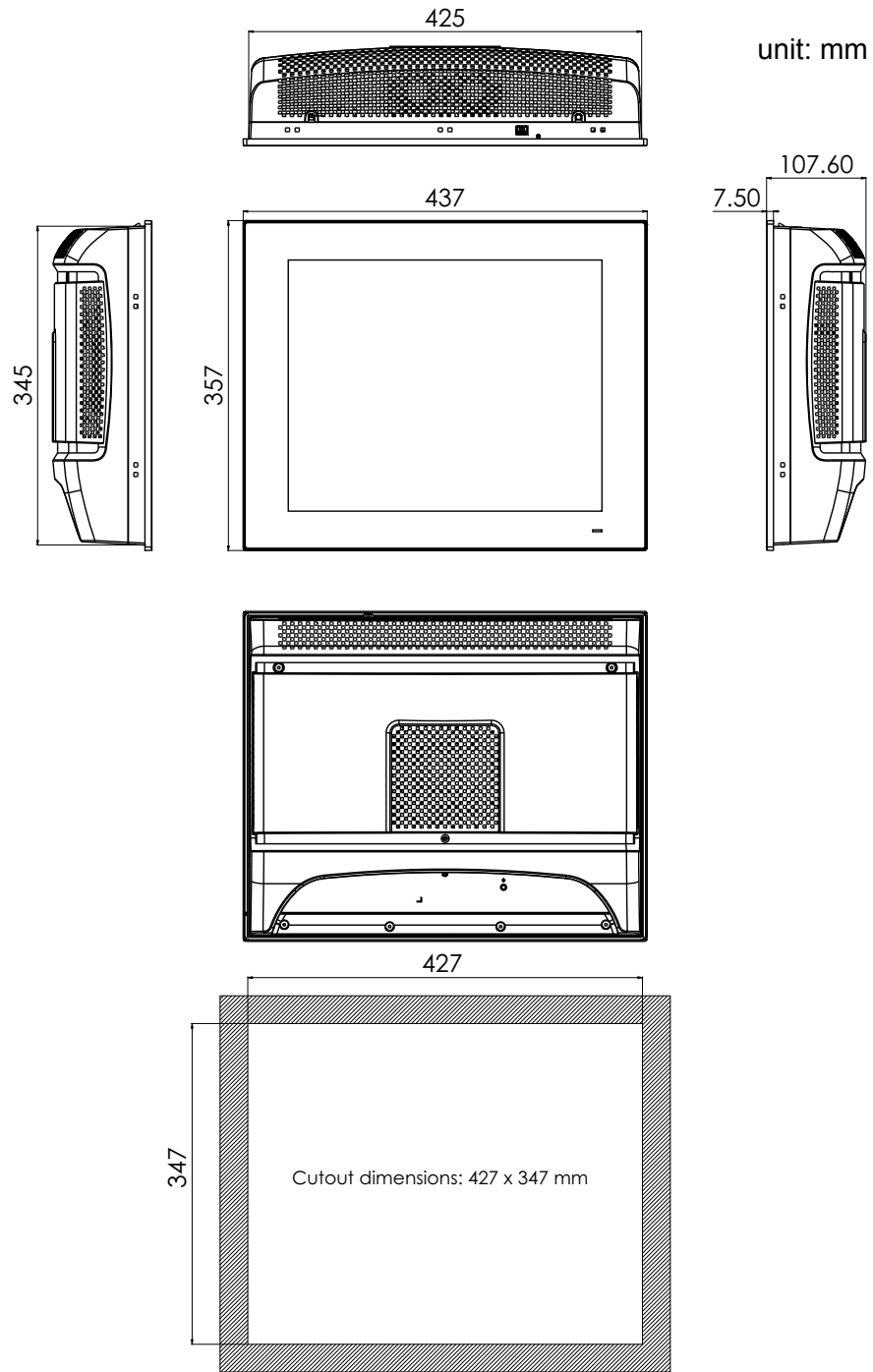

Figure 1.2 PPC-6171C dimensions

Unit:mm

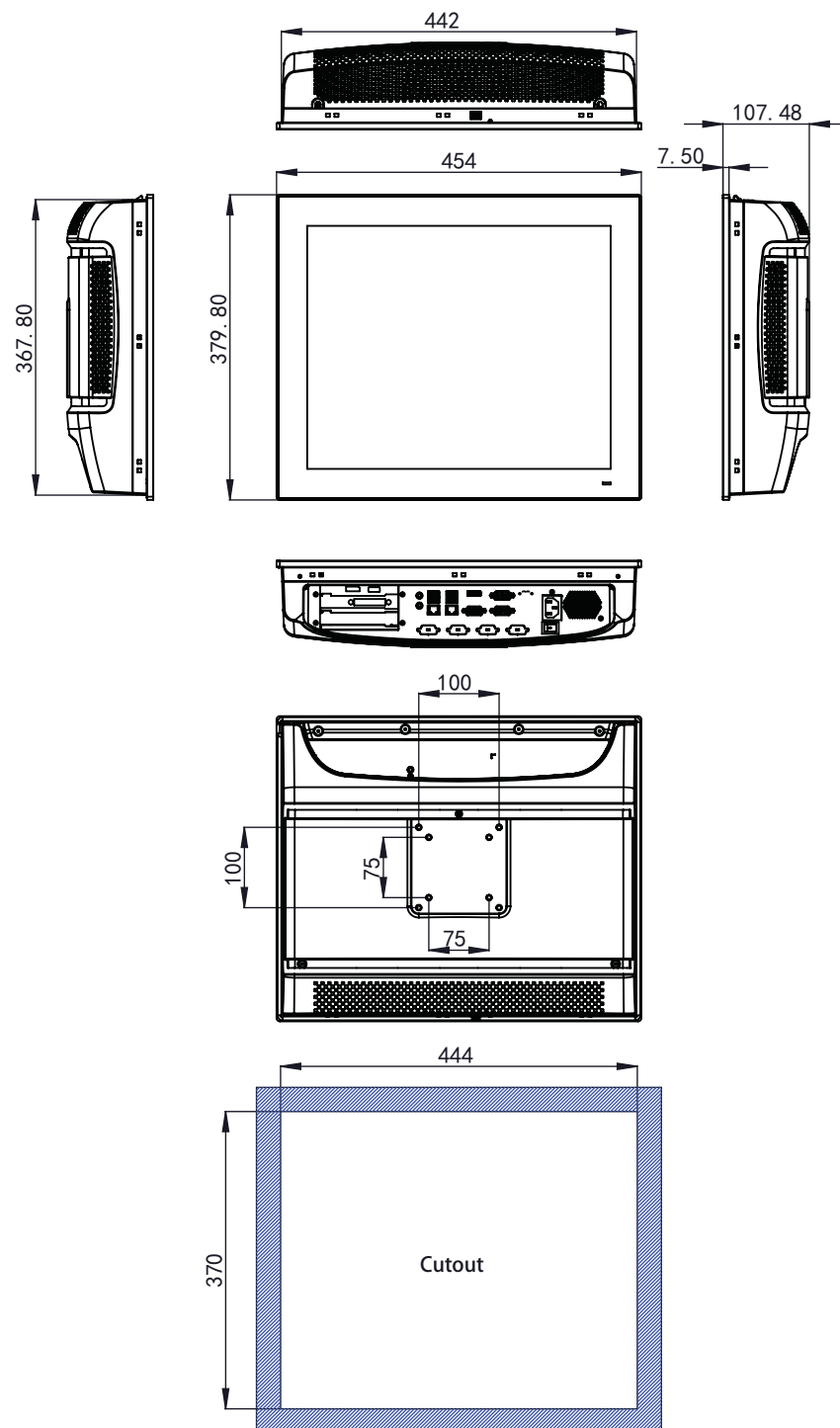

Figure 1.3 PPC-6191C dimensions

Fixed VESA screw specification: M4; screw depth: 8 mm (Max)

**Warning!** Use suitable mounting apparatus to avoid risk of injury.



# Chapter 2

## System Installation and Setup

- Anti-Static Precautions
- Installation Procedures
- PPC-6151C/6171C/6191C-RTAE  
Motherboard Installation
- PPC-6151C/6171C/6191C-RMAE  
Motherboard Installation
- Component Setup
- Mount Installation
- Quick Installation

## 2.1 Anti-Static Precautions

**Warning!** Failure to take appropriate ESD precautions during maintenance may result in permanent damage to the PPC and severe injury to the user.



Electrostatic discharge (ESD) can cause serious damage to electronic components, including the PPC model. ESD is especially common in dry climates. Therefore, when manually handling or accessing any of the PPC model's internal components, anti-static precautions should be strictly followed.

Always wear an anti-static wristband when handling the PPC model; this can prevent ESD from damaging the board or causing personal injury.

**Note!** Refer to Chapter 1.3 (Chassis Comparison) to determine the chassis type, then refer to Chapters 2.3 and 2.4 (for PPC-6151C/6171C/6191C-RTAE and PPC-6151C/6171C/6191C-RMAE, respectively) for the installation guidelines.



## 2.2 Installation Procedures

The procedures listed below must be followed to ensure correct installation.

<b>2.3 PPC-6151C/6171C/6191C-RTAE Motherboard Installation</b>	
Remove the back cover	2.3.1
Remove the reinforced bracket	2.3.2
Check and adjust the jumpers on the PPC-MB-8260AE motherboard	2.3.3
Install the PPC-MB-8260AE motherboard	2.3.4
Connect the motherboard wires	2.3.5
<b>2.4 PPC-6151C/6171C/6191C-RMAE Motherboard Installation</b>	
Remove the back cover	2.4.1
Remove the reinforced bracket	2.4.2
Check and adjust jumper settings	2.4.3
Install the Mini-ITX motherboard (AIMB-275)	2.4.4
Connect the motherboard wires	2.4.5
Connect the daughter board and motherboard with a cable	2.4.6
<b>2.5 Component Setup</b>	
CPU installation	2.5.1
CPU cooler installation	2.5.2
Memory card installation	2.5.3
HDD installation	2.5.4
Wi-Fi module installation	2.5.5
Expansion card installation	2.5.6
Rear cover installation	2.5.7

## 2.3 PPC-6151C/6171C/6191C-RTAE Motherboard Installation

### 2.3.1 Remove the Back Cover

Unscrew the six screws and remove the rear cover.

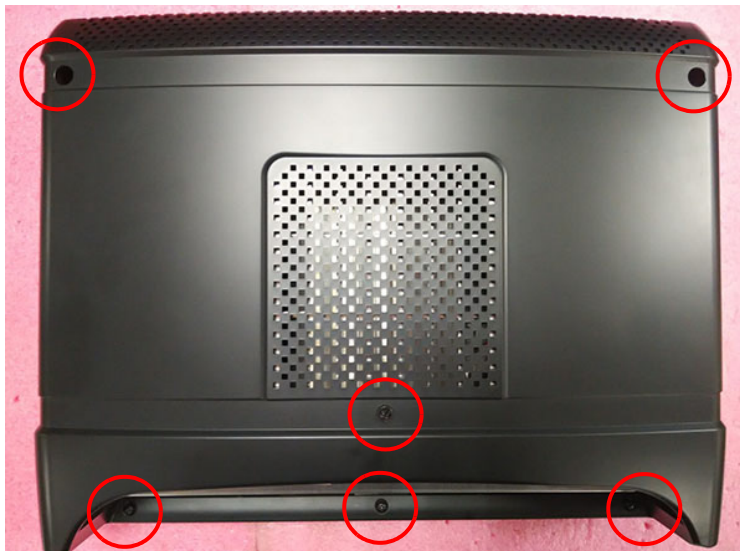

### 2.3.2 Remove the Reinforced Board

Remove the two screws of the reinforced board.

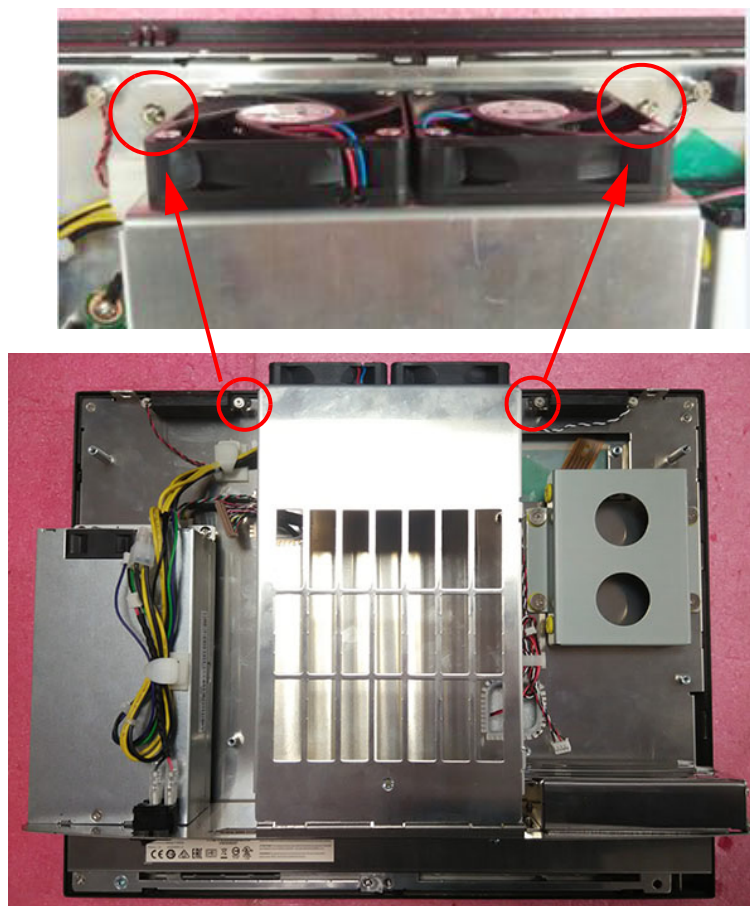

### 2.3.3 Check and Adjust Jumpers on the Motherboard

The image below shows the PPC-MB-8260AE motherboard with PPC-6151C-RTAE.

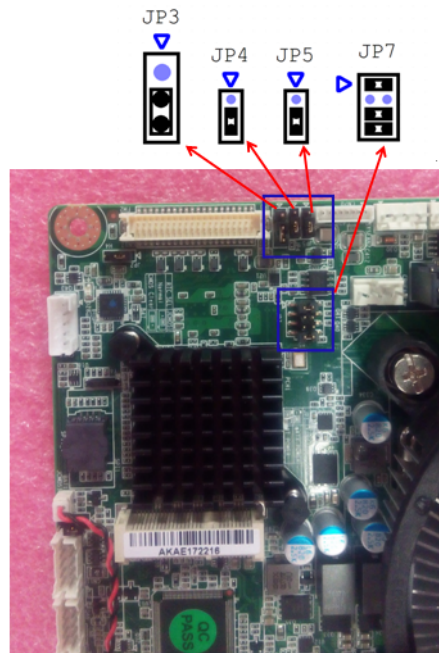

JP7	Resolution	1024 x 768 (24 bit)
JP3	LED panel PWR	+3.3 V
JP4	Backlight level	+3.3 V
JP5	Brightness PWM level	+3.3 V



The image below shows the PPC-MB-8260AE motherboard with PPC-6171C-RTAE.

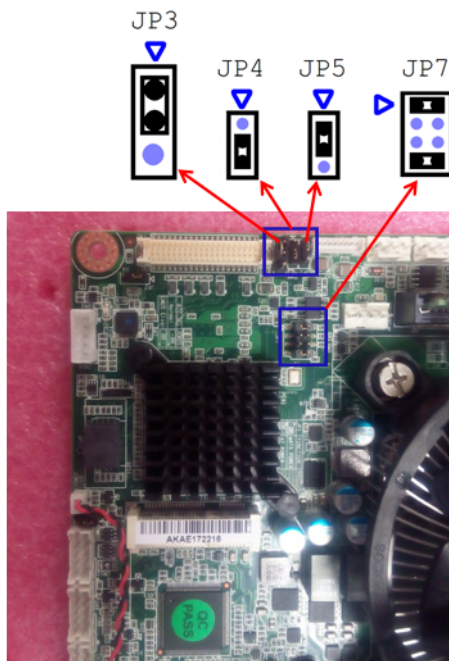

JP7	Resolution	1280 x 1024 (24 bit)
JP3	LED panel PWR	+5 V
JP4	Backlight level	+3.3 V
JP5	Brightness PWM level	+5 V

The image below shows the PPC-MB-8260AE motherboard with PPC-6191C-RTAE.

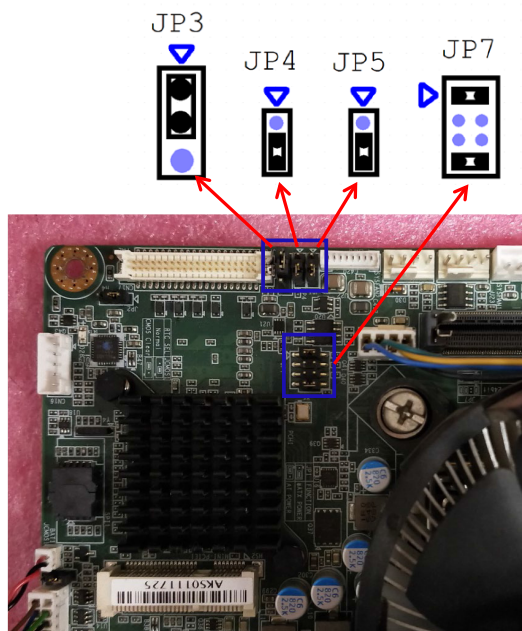

JP7	Resolution	1280 x 1024 (24 bit)
JP3	LED panel PWR	+5 V
JP4	Backlight level	+3.3 V
JP5	Brightness PWM level	+3.3 V

**Note!** For more information regarding the jumpers and connectors, please refer to the PPC-MB-8260AE startup manual (P/N:2003826000).



### 2.3.4 Install the PPC-MB-8260AE Motherboard

Using the four screws provided in the accessory box, affix the motherboard to the motherboard frame. (Motherboards must be purchased separately.)

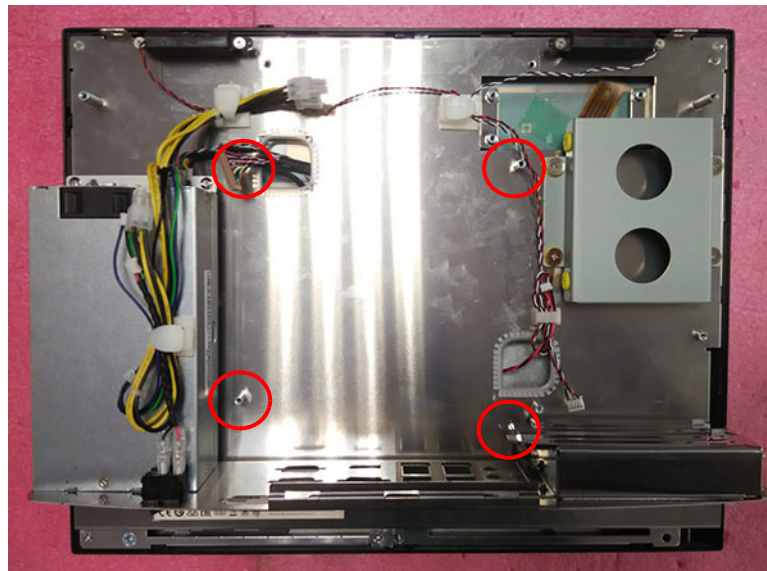

**Note!** Please refer to the datasheet when selecting the motherboard type in order to ensure optimum performance, maximum security, and sufficient air circulation.





### 2.3.5 Connect the Motherboard Wires

PPC-6151C/6171C/6191C-RTAE and PPC-MB-8260AE assembly

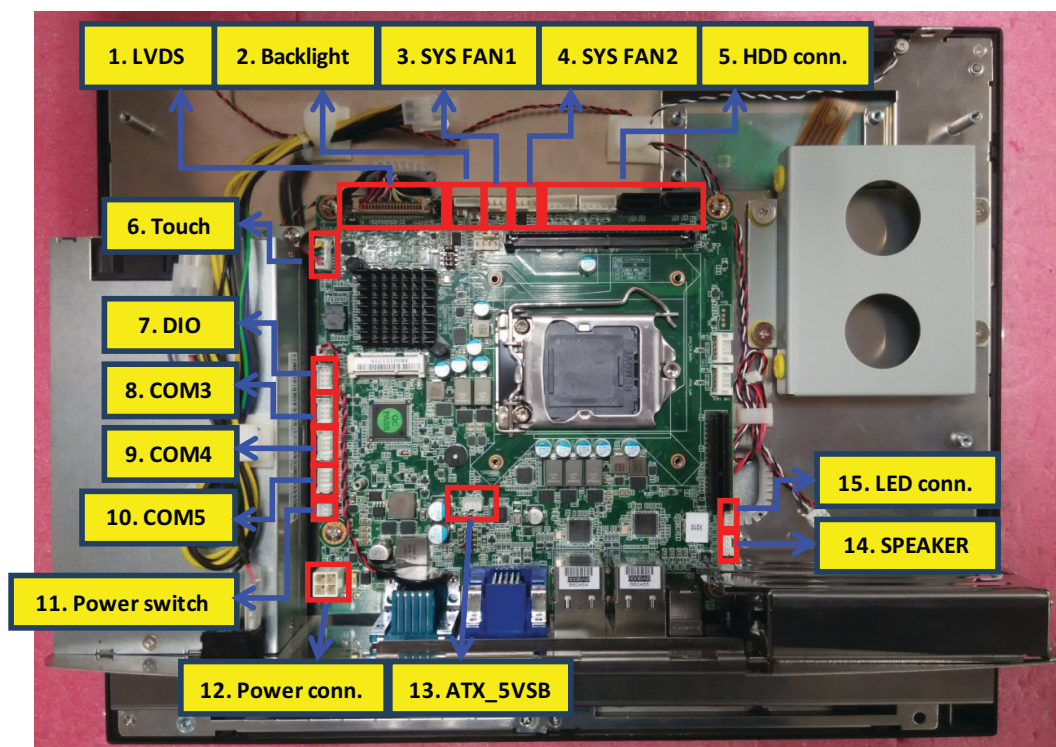

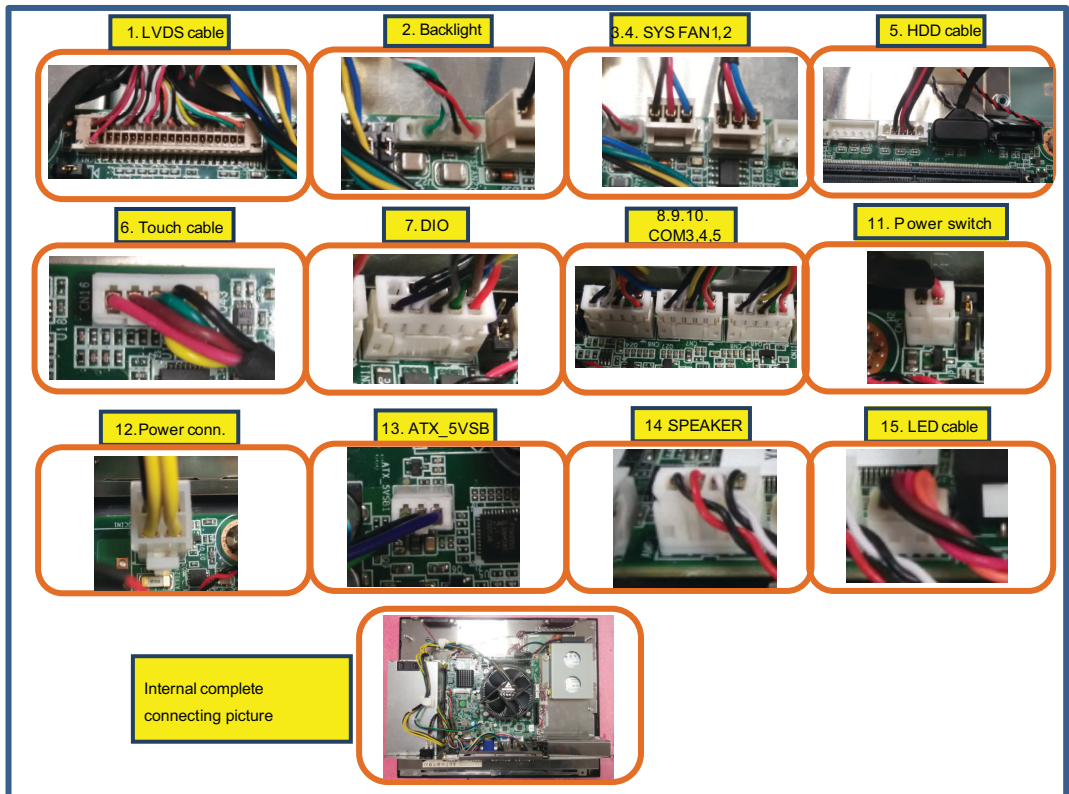

- Note!**
- 1. The COM cable and DIO cable are the same.
  - 2. The cable connection is based on the motherboard specifications.

## 2.4 PPC-6151C/6171C/6191C-RMAE Motherboard Installation

### 2.4.1 Remove the Back Cover

Unscrew the six screws and remove the rear cover.

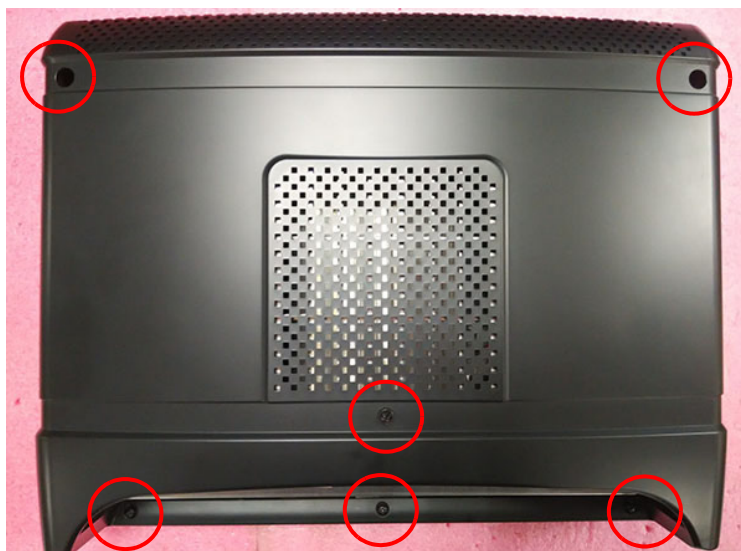

## 2.4.2 Remove the Reinforced Bracket

Remove the two screws of the reinforced bracket.

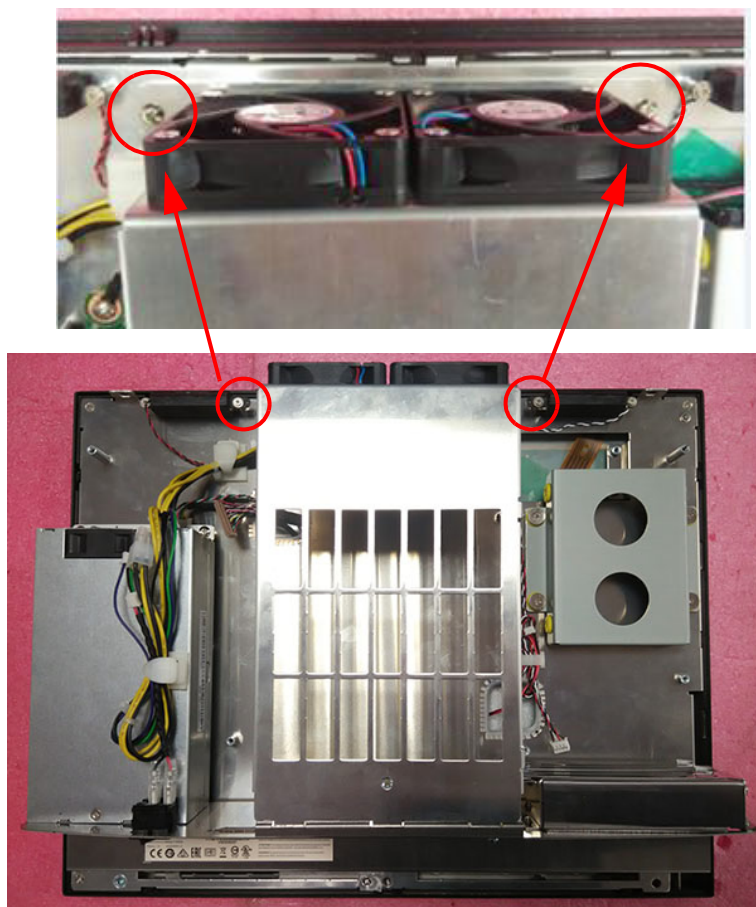

## 2.4.3 Check Jumper Setting of the Chassis

The image below shows the AIMB-275 motherboard with PPC-6151C-RMAE.

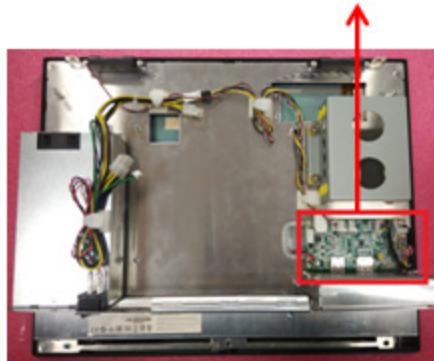
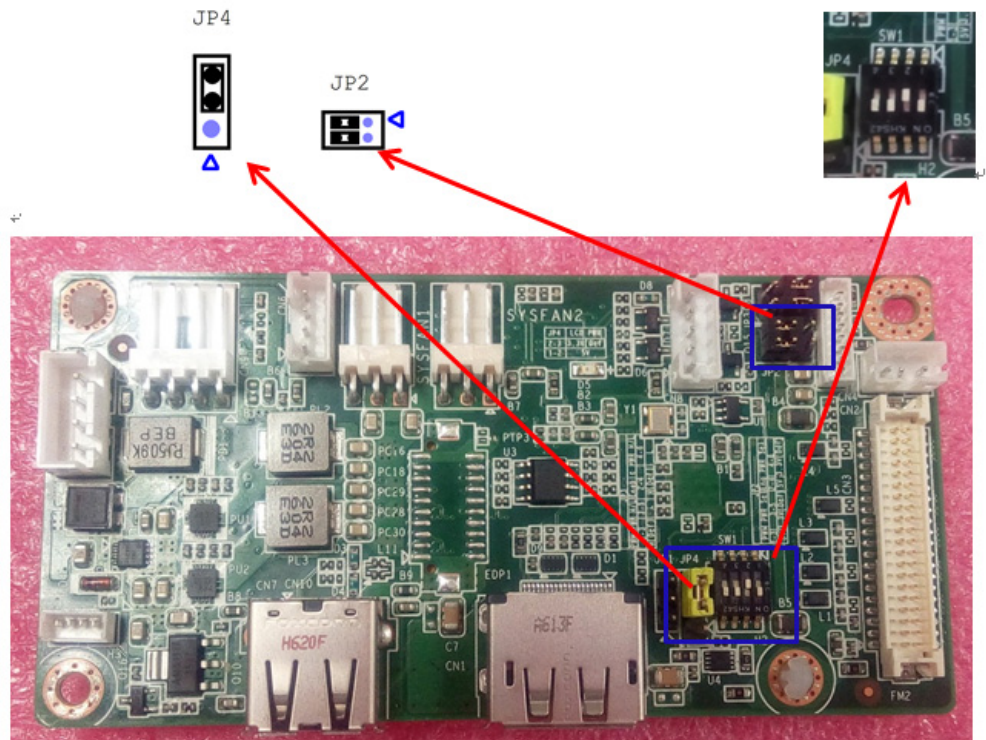

SW1	Resolution	1024 x 768 (24 bit)
JP4	LED panel PWR	+3.3 V
JP2(4-6)	Backlight level	+3.3 V
JP2(3-5)	Brightness PWM level	+3.3 V

The image below shows the AIMB-275 motherboard with PPC-6171C-RMAE.

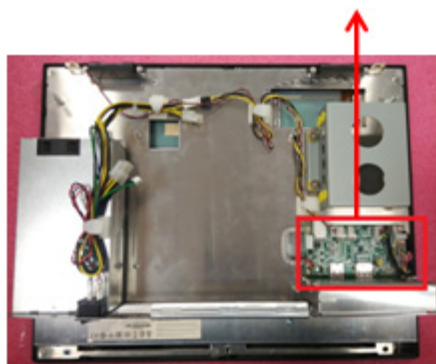
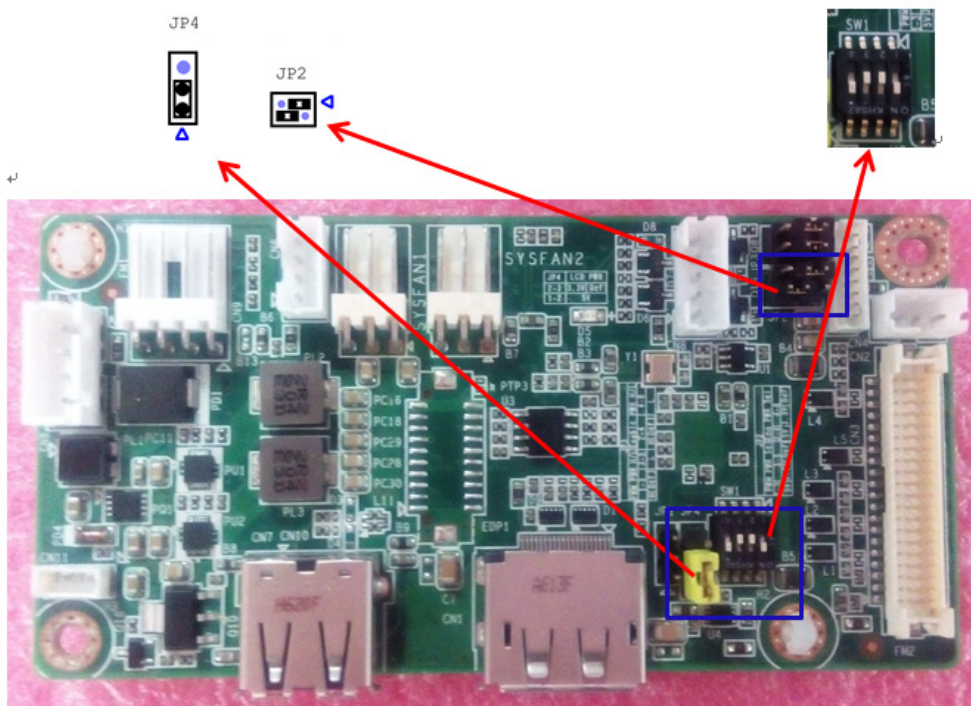

SW1	Resolution	1280 x 1024 (24 bit)
JP4	LED panel PWR	+5 V
JP2(4-6)	Backlight level	+3.3 V
JP2(1-3)	Brightness PWM level	+5 V

The image below shows the AIMB-275 motherboard with PPC-6191C-RMAE.

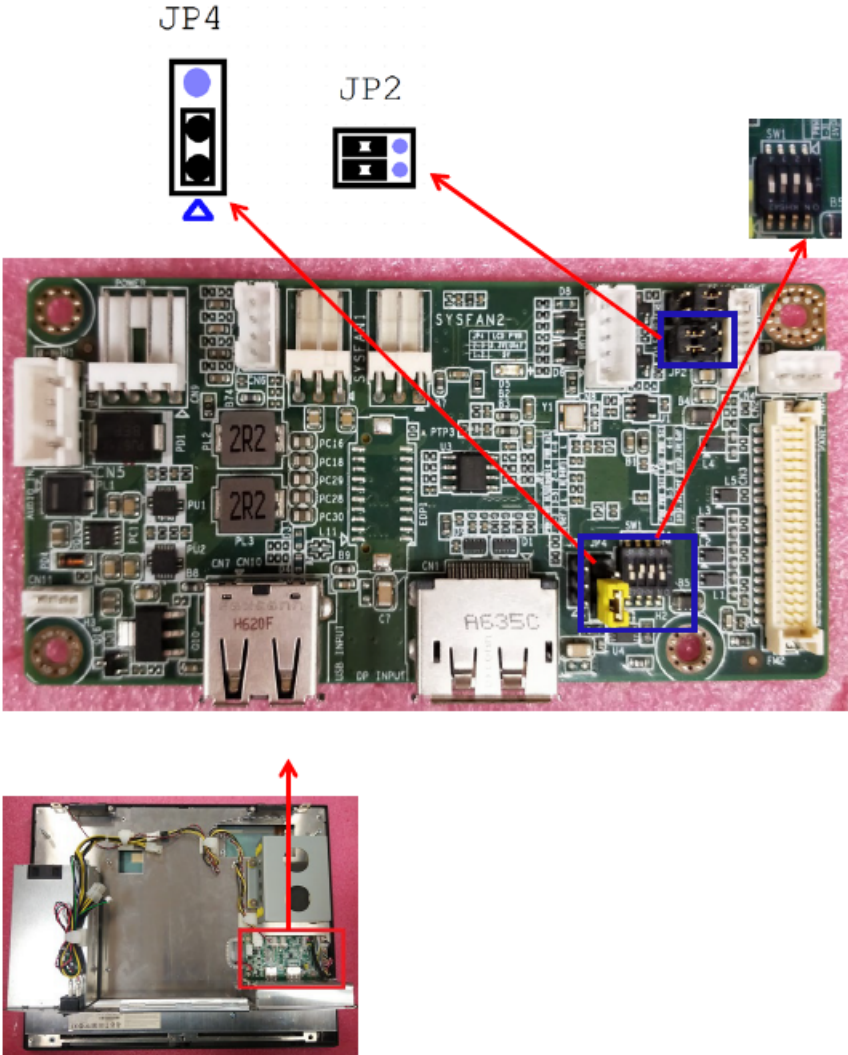

SW1	Resolution	1280 x 1024 (24 bit)
JP4	LED panel PWR	+5 V
JP2(4-6)	Backlight level	+3.3 V
JP2(3-5)	Brightness PWM level	+3.3 V



## 2.4.4 Install the Mini-ITX Motherboard (AIMB-275)

1. Retrieve the I/O bracket from the AIMB-275 accessory box.



2. Remove the I/O port blades.

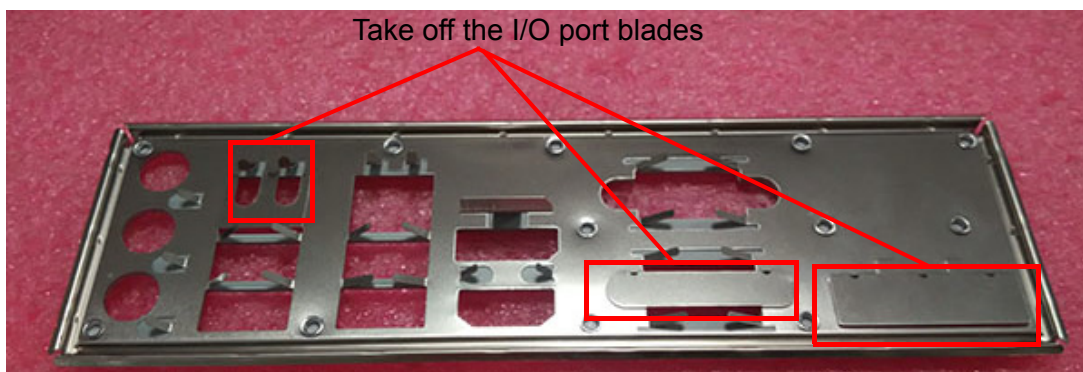

3. Install the motherboard I/O bracket into the chassis.

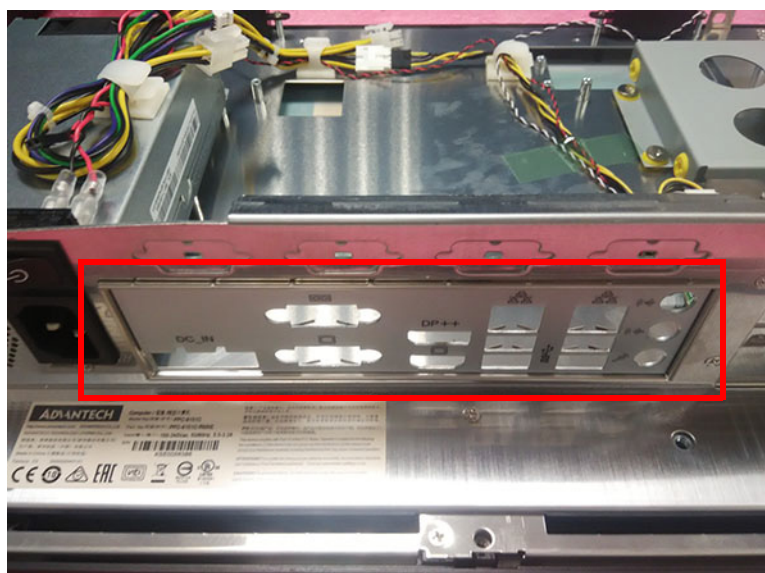

- Use four screws from the accessory box to affix the motherboard in place.

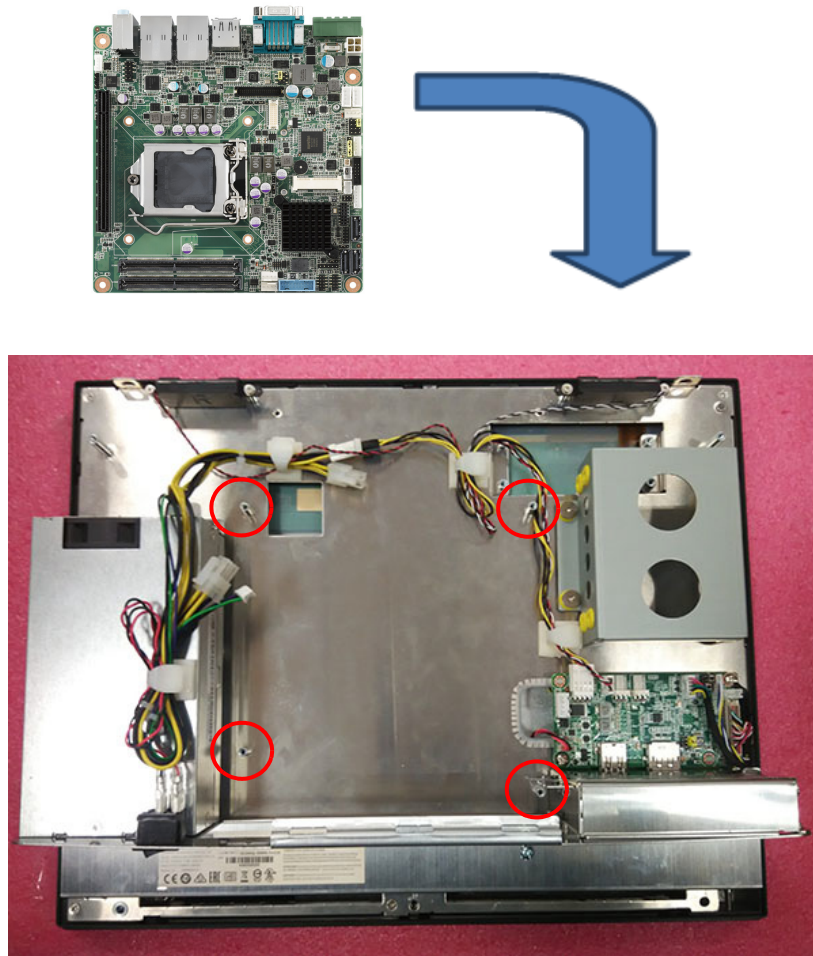

### 2.4.5 Connect the Motherboard Wires

PPC-6151C/6171C/6191C-RMAE and AIMB-275 assembly

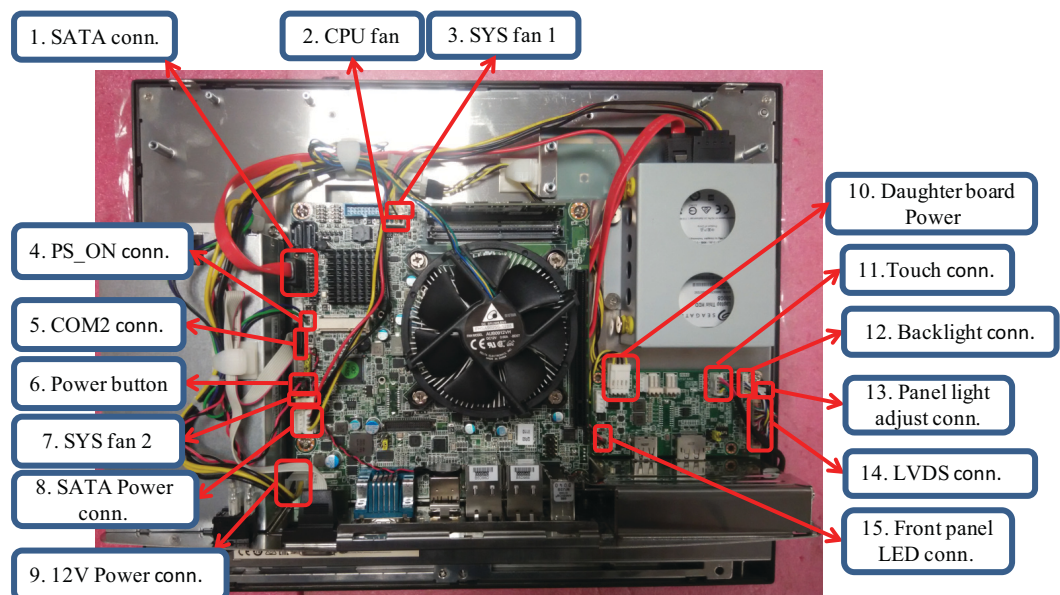

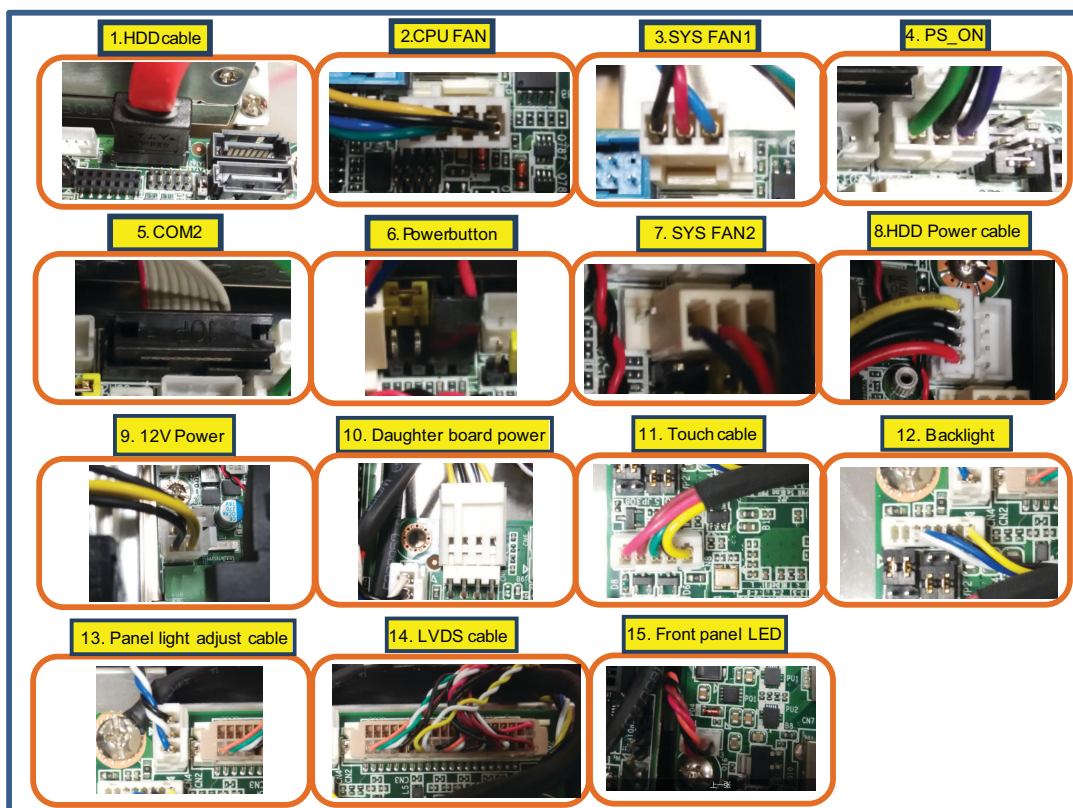

1. Connect the daughter board power cable and FAN2 cable

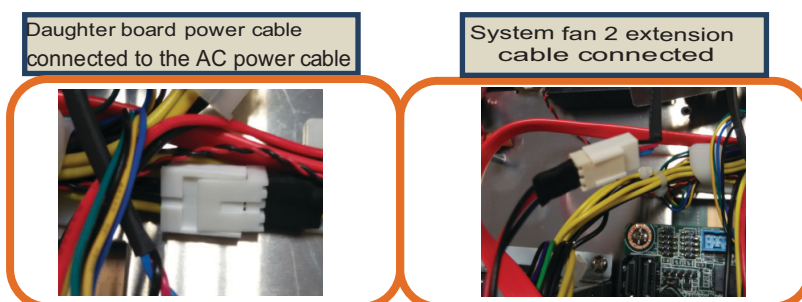

2. Connect the speaker cables as shown below.

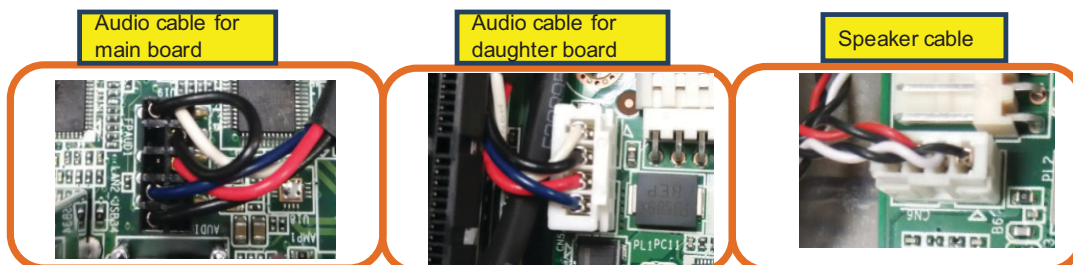

**Note!** Please refer to the PPC-6151C/6171C/6191C selection guide when selecting the motherboard type in order to ensure optimum performance, maximum security, and sufficient air circulation. The cable connection is based on the motherboard specifications.



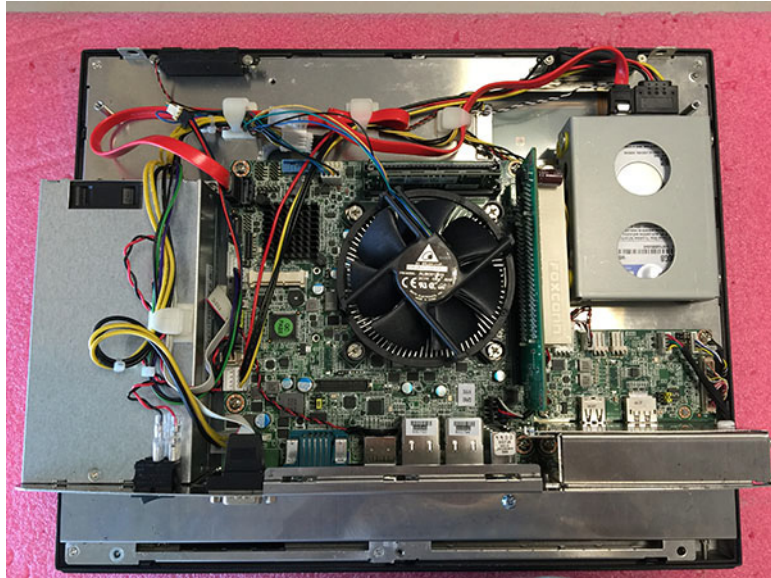

3. Retrieve DC bracket screws from the accessory box and affix the DC bracket in place.

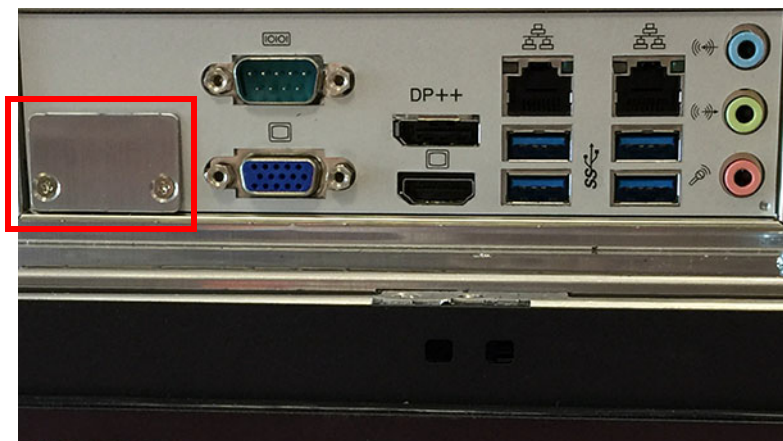

**Note!** For the PPC-6151C/6171C/6191C model, users are advised not use the DC port on the motherboard.



## 2.4.6 Connect the Daughter Board and Motherboard Using a Cable

1. Connect the DP input port with the motherboard DP port to enable the display. Connect the USB Input port with a motherboard USB port to enable touch function. (Cables are included in the accessory box.)

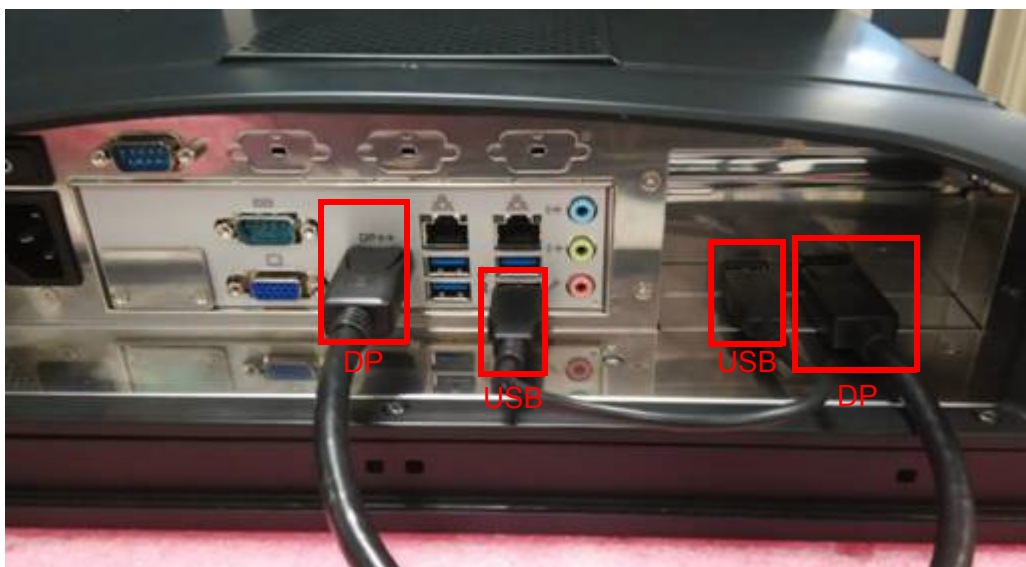

2. Connect the motherboard.

**Note!** Use a DP cable to connect the motherboard DP port and the chassis DP input port. Use a USB cable to connect one of the motherboard USB ports. The motherboards must have a DP port.



3. Connect the daughter board.



## 2.5 Component Setup

### 2.5.1 CPU Installation

Remove the CPU socket cover and install the CPU.

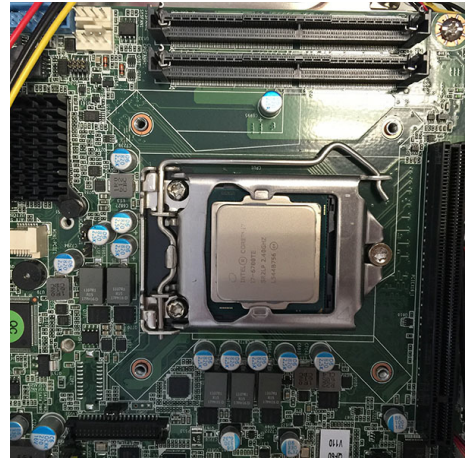
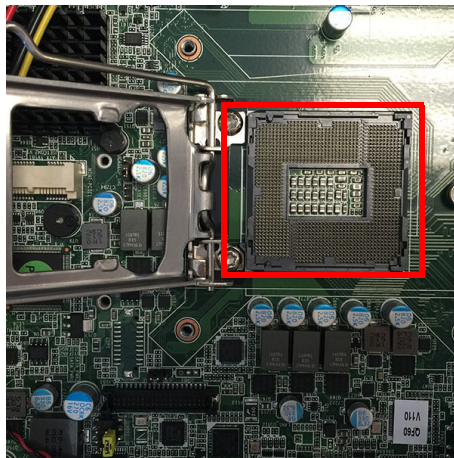

**Note!** Exercise caution when handling the motherboard CPU pins.  
Refer to the datasheet when selecting the motherboard CPU.



**Note!** After CPU installation, ensure the CPU surface is covered in thermal grease. (Thermal grease is included in the PPC-MB-8260AE motherboard accessory box.)



## 2.5.2 CPU Cooler Installation

Using four screws, affix the cooler onto the motherboard. Then connect the cable to the motherboard. (Refer to the datasheet when selecting the CPU cooler. The cooler must be purchased separately.)

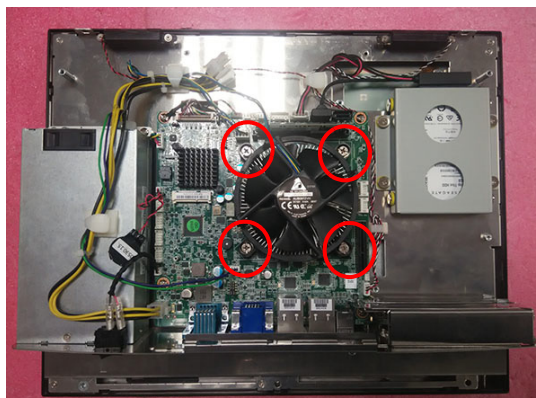

## 2.5.3 Memory Installation

### 1. PPC-MB-8260AE motherboard

- 1). Insert the memory card into the slot at a 45-degree angle. The gold fingers on the edge of the card must be completely inserted into the slot to ensure a secure connection.

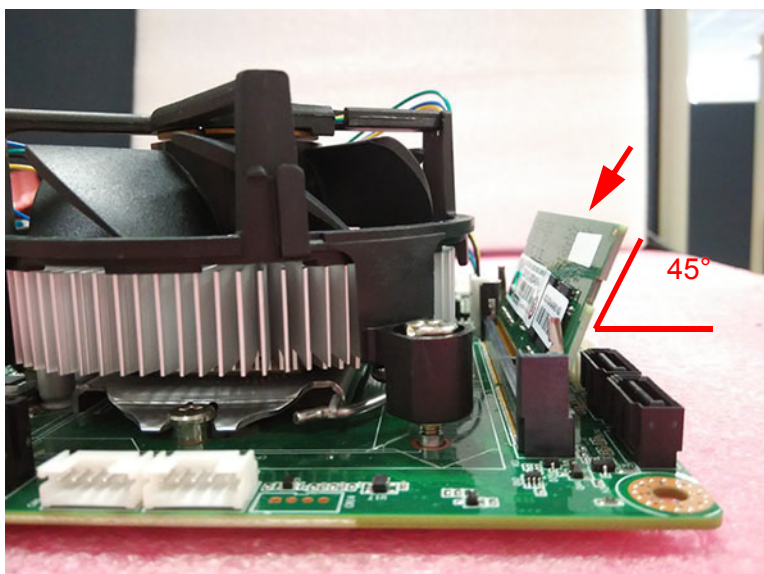

- 2) When the card is in the slot, apply firm pressure to the card until the clamps on the side click and lock the card into place.

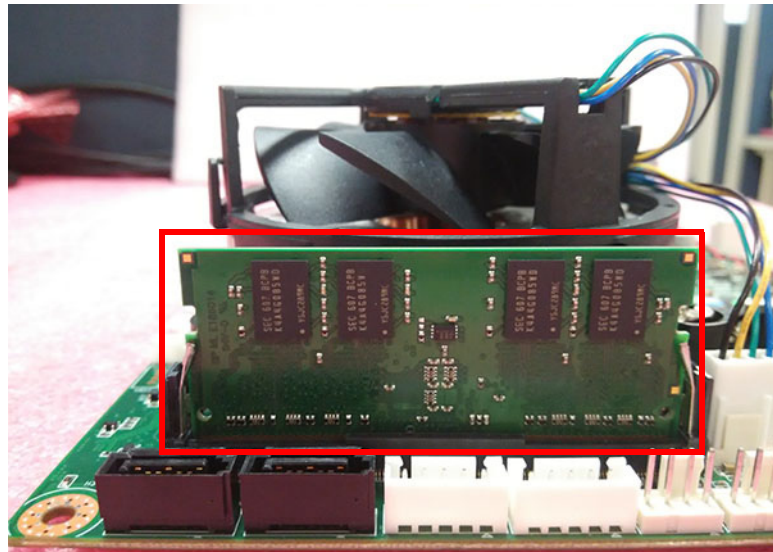

## 2. AIMB-275 motherboard

- 1). Insert the memory card into the slot at a 45-degree angle. The gold fingers on the edge of the card must be completely inserted into the slot to ensure a secure connection.

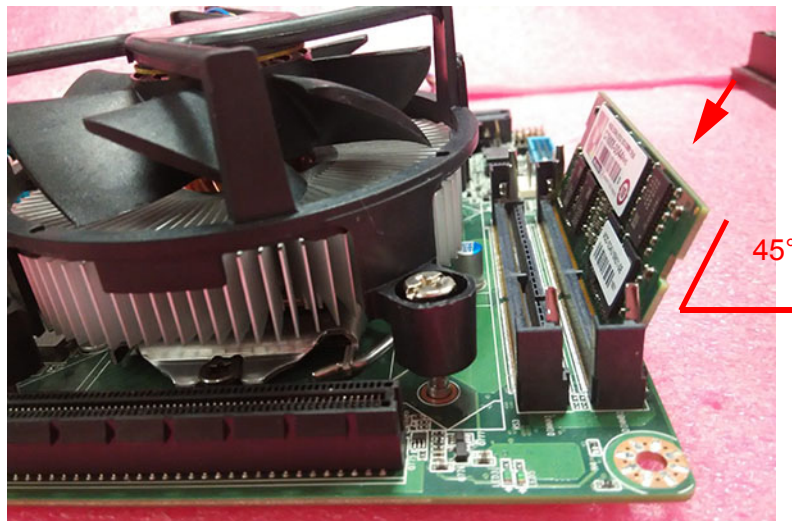



- 2) When the card is in the slot, apply firm pressure to the card until the clamps on the side click and lock the card into place.

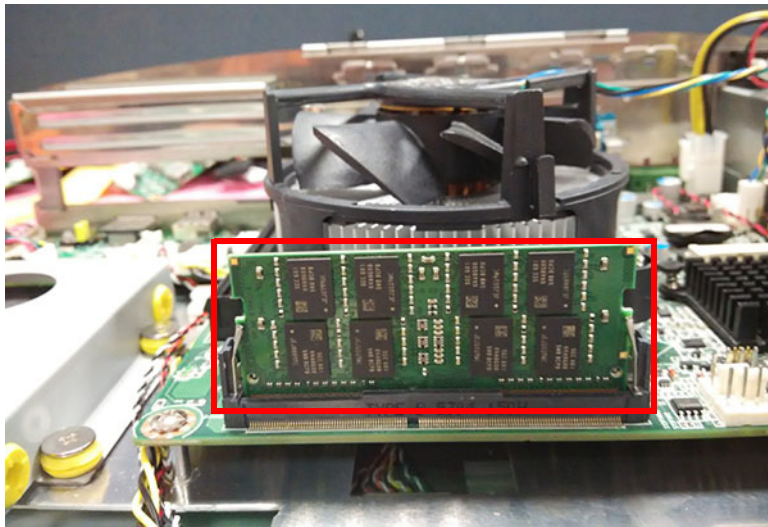

### 2.5.4 HDD Installation

1. Unscrew the four screws indicated in the image below. Then remove the HDD bracket.

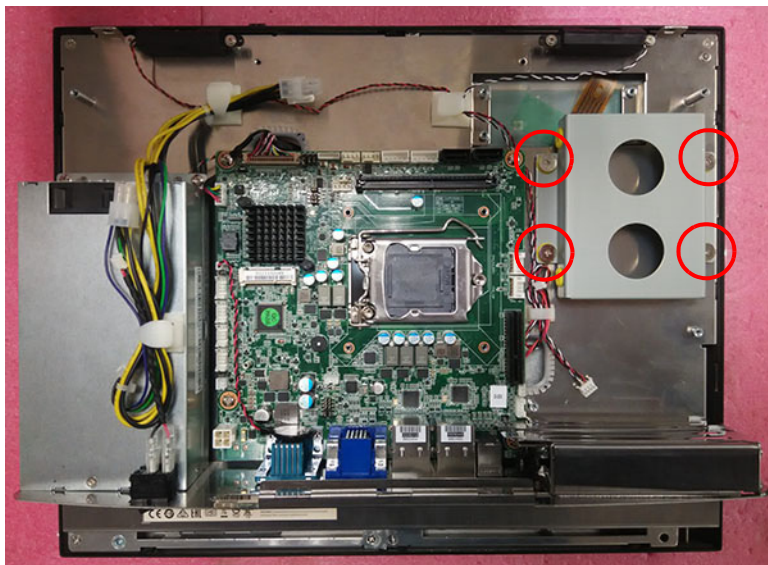

2. Place the HDD into the HDD bracket and affix it into place using four screws. (HDD screws are included in the accessory box.)



3. Reattach the HDD bracket and connect the SATA HDD cable. The assembled HDD module should appear as shown below.

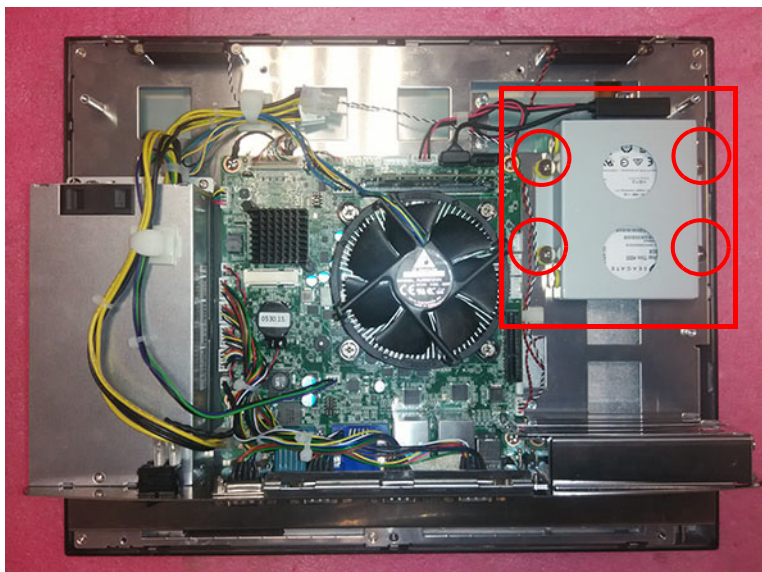

### 2.5.5 Wi-Fi Module Installation

In the procedures listed below for installing a wireless LAN card, a PPC-WLAN-A1E motherboard is used in the example images.

1. Attach the wireless LAN card to the ironware bracket using the screws provided with the Wi-Fi module.



2. Insert the wireless card into the appropriate mainboard slot. Then affix the card in place using a screw provided in the accessory box.



3. Connect the cables of the wireless LAN card to the antenna holder. Note the installation direction of the cable end and nut/washer.

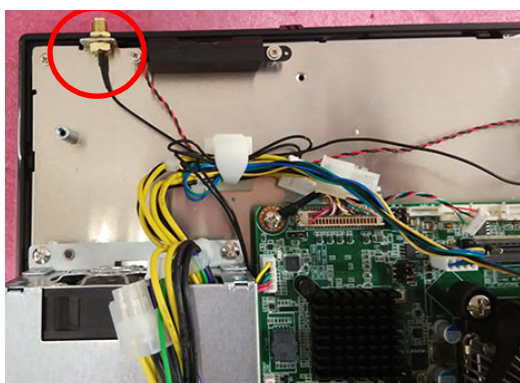

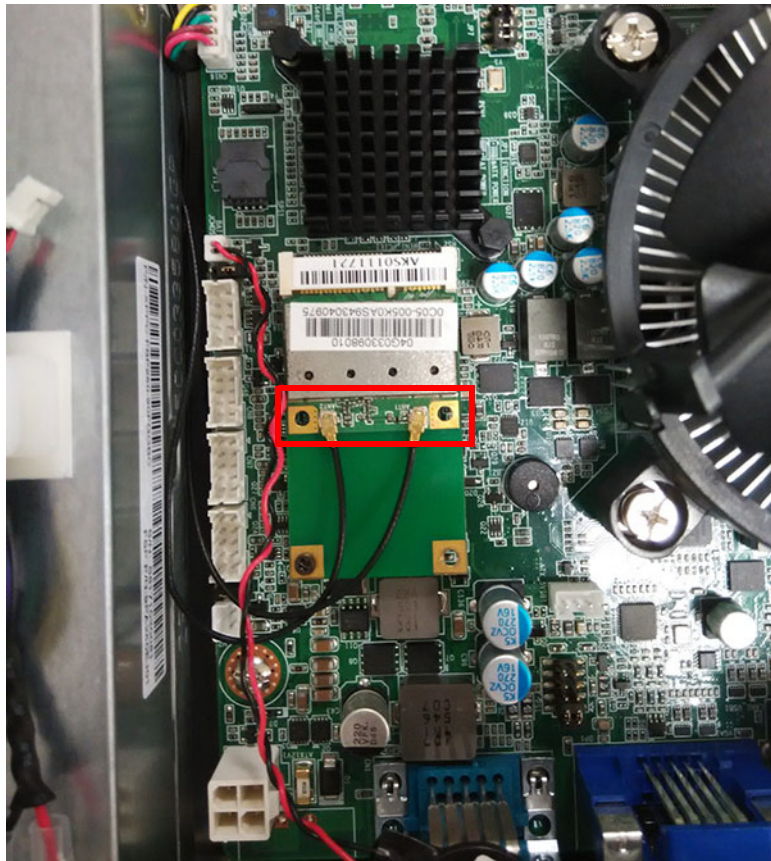

4. Lock the assembled antenna holder onto the machine. Then connect the cable to the wireless LAN card.

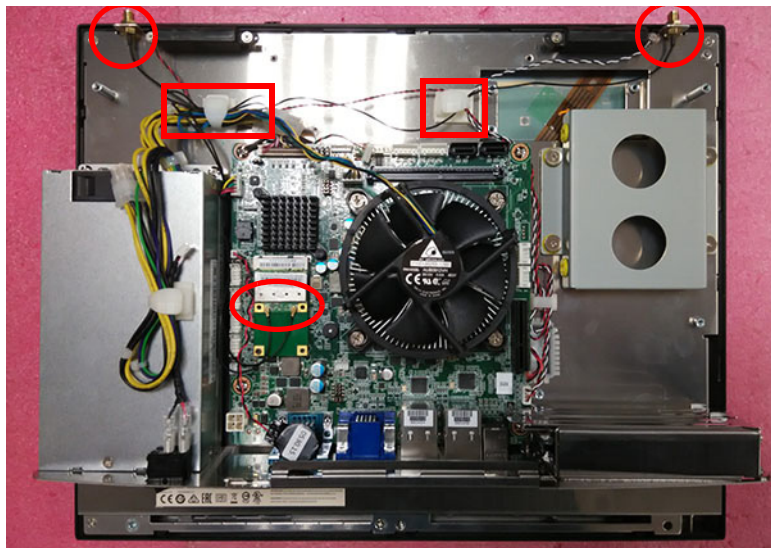

5. Install the bracket and then replace the rear cover (see Section 2.5.7).
6. Attach the wireless module antenna to complete installation.



### 2.5.6 Expansion Card Installation

1. Insert the PCI riser card (included in the PPC-6151C/6171C/6191C accessory box) into the slot and affix it in place using two screws. One PCIe x4 and two PCI riser cards are provided in the PPC-6151C/6171C/6191C accessory box, allowing users to customize the system according to their requirements.

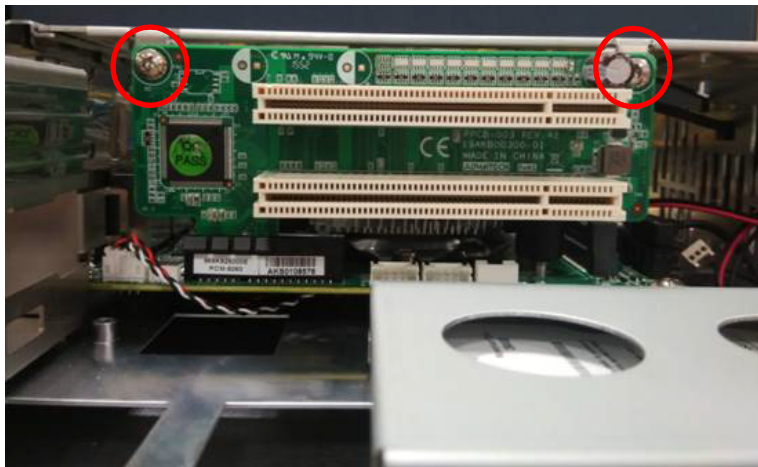

2. To change the PCI riser card to a PCIe x4 riser card, first remove the PCI riser card. Then insert the PCIe x4 riser card and affix it in place using two screws.

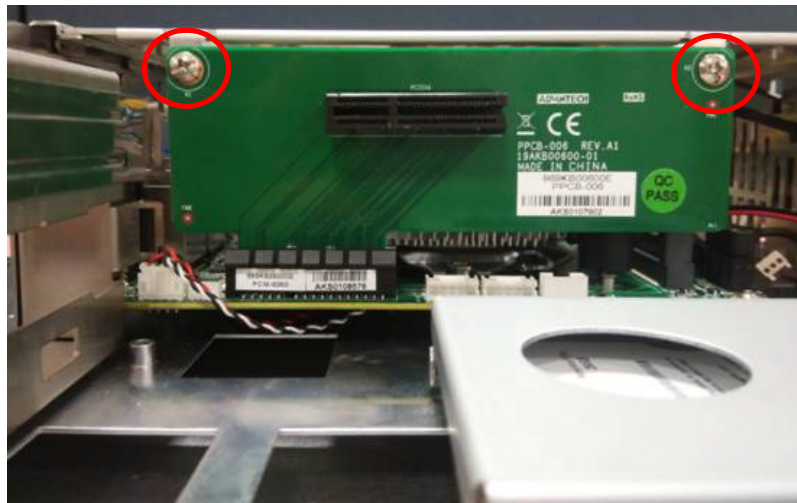

### 2.5.7 Rear Cover Installation

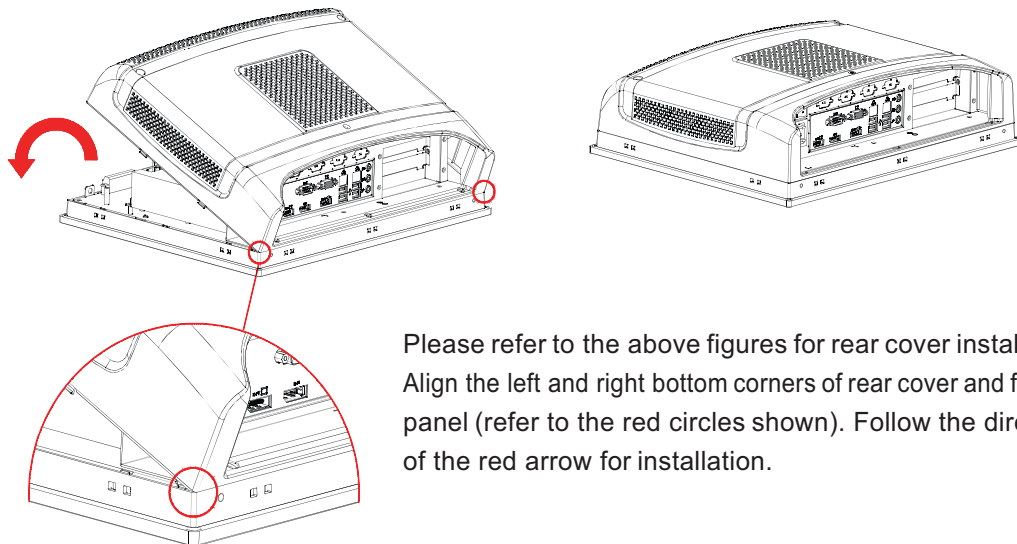

Please refer to the above figures for rear cover installation. Align the left and right bottom corners of rear cover and front panel (refer to the red circles shown). Follow the direction of the red arrow for installation.



## 2.6 Mount Installation

**Warning!** When mounting the panel PC, we recommend having at least one other person to assist with the mounting in order to prevent accidental damage to the panel and/or personal injury.



### Panel Mount Bracket Installation

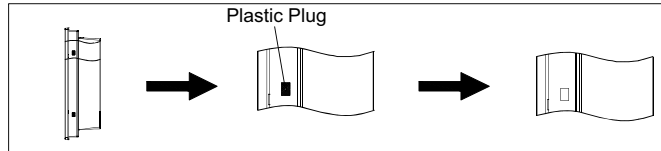

↓ Remove the plastic plugs around the machine using tweezers.

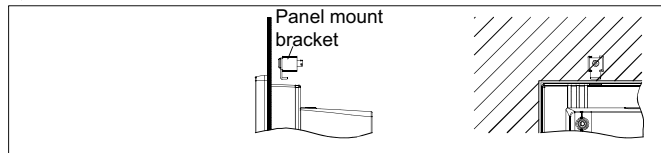

↓ Put the machine into the cabinet and get the wall mount brackets.

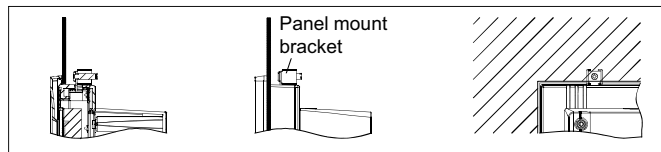

↓ Fix the machine in place by tightening the screws.

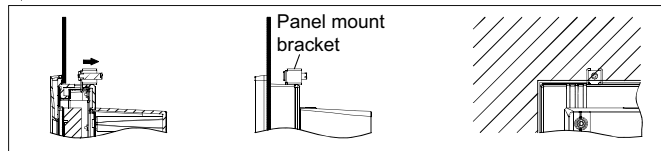

↓ Replace the plastic plugs according to the arrow and hookup machine.

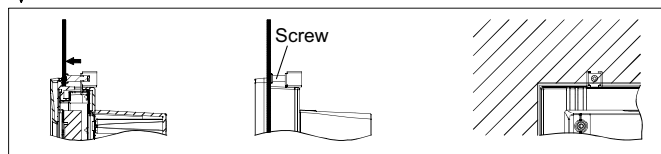

↓ Fix the machine in place by tightening the screws.

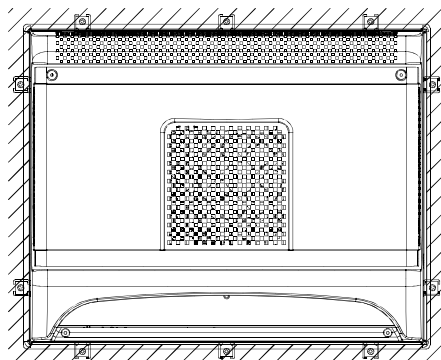

## 2.7 Quick Installation

Users can independently complete the panel wall mount installation by following the quick installation procedures listed below.

1. Loosen the two screws at the base (see the figure below).



2. Push the machine into a gap in the wall. The spring hook will lock the machine into the wall.





3. After mounting, the panel should appear as shown in the figure below. Then at the rear of the machine, lock the hook screw to fix the machine in place.

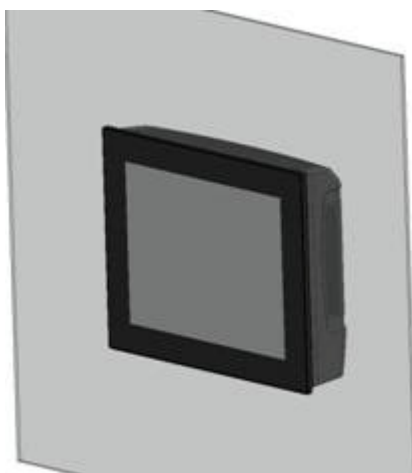

**Note!** According to the quick installation guide, the recommended mount thickness is no more than 2 mm (0.079 in). For other situations, the recommended thickness is 6 mm or less (0.236 in).





# Chapter 3

## System Maintenance

## 3.1 Introduction

The following system components may require maintenance:

- Power supply
- Daughter board
- System fan

**Warning!** *If the above components fail, they must be replaced. Contact the system vendor to purchase replacement parts. Instructions for replacing the components are provided in subsequent sections.*



## 3.2 AC Power Supply Replacement

Please read the warning at the beginning of the previous chapter before attempting to access any of the PPC's internal components.

1. Follow the steps in Sections 2.3.1 and 2.3.2.
2. Remove the four screws from the power bracket.

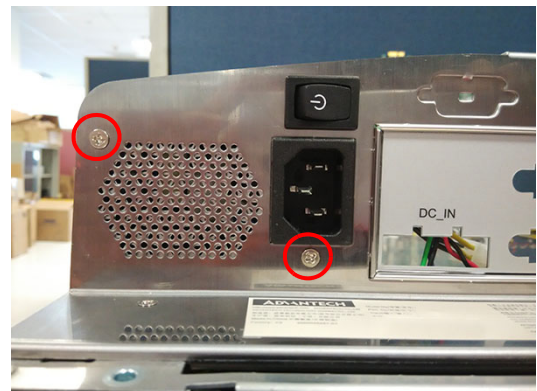
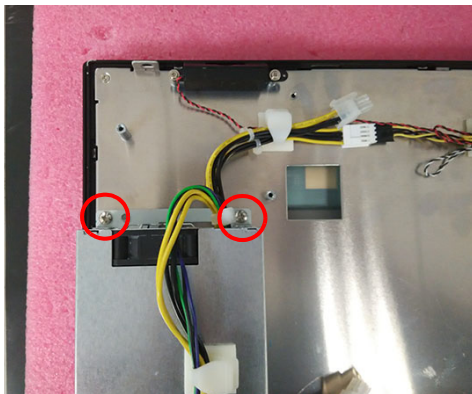

3. Disconnect the power from the motherboard frame.

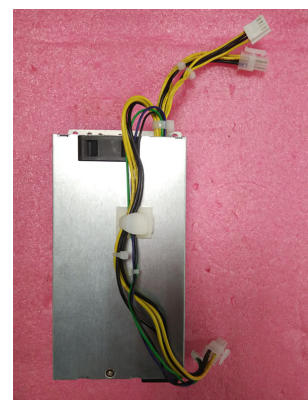
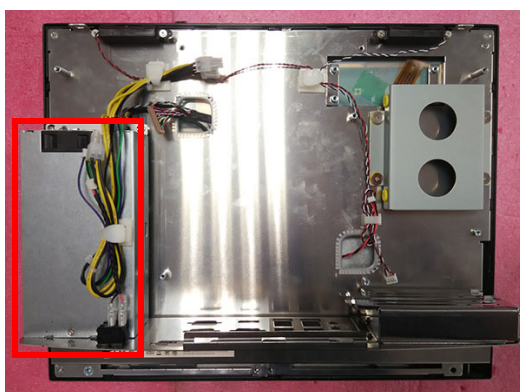

### 3.3 Daughter Board Replacement

1. Unplug the DP and USB cables from the device.



2. Remove the rear cover to access the daughter board. Next, disconnect the power cable, speaker cable, touch cable, backlight cable, LVDS cable, LED cable, and audio cable, and also remove the two screws, as shown below.

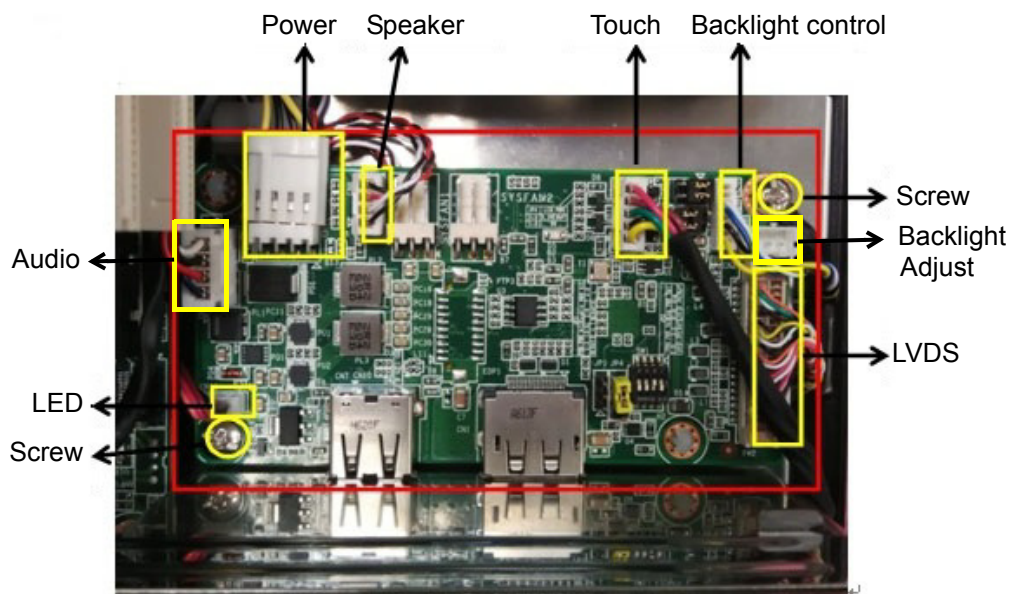

3. Remove the old daughter board and replace it with a new daughter board.

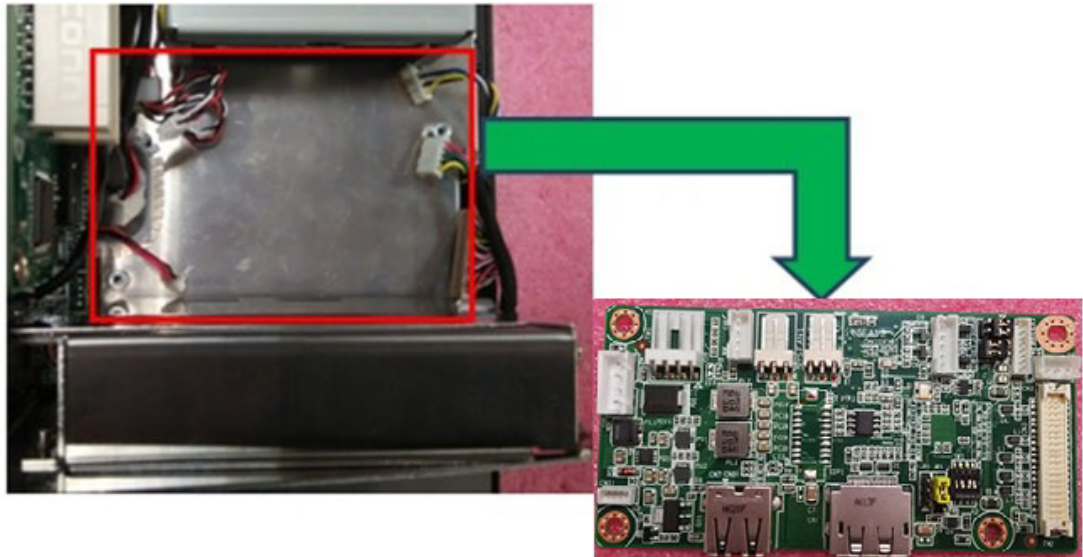

### 3.4 System Fan Replacement

1. Remove the eight screws from the reinforced bracket.



2. Untie the system fan cable and remove the fan



### 3.5 LCD and Touch Panel Replacement

The touch panel is attached to the front of the display using an adhesive. All surfaces must be thoroughly cleaned before adhesion to ensure durable bonding. Therefore, users are not advised to replace the touch panel themselves. Should you require a replacement, contact Advantech's Customer Service center.





# Appendix **A**

PCI/PCIE Riser Card

## A.1 Riser Card Introduction

### A.1.1 PPCB-003 PCI Riser Card

The total current load provided by the PPC-6151C/6171C/6191C PCI slot does not exceed 20 W. Additional details are provided below.

-12 V	0.1A
+12 V	0.5A
+5 V	4A
+3.3 V	2.5A
+3.3 VSB	0.25A

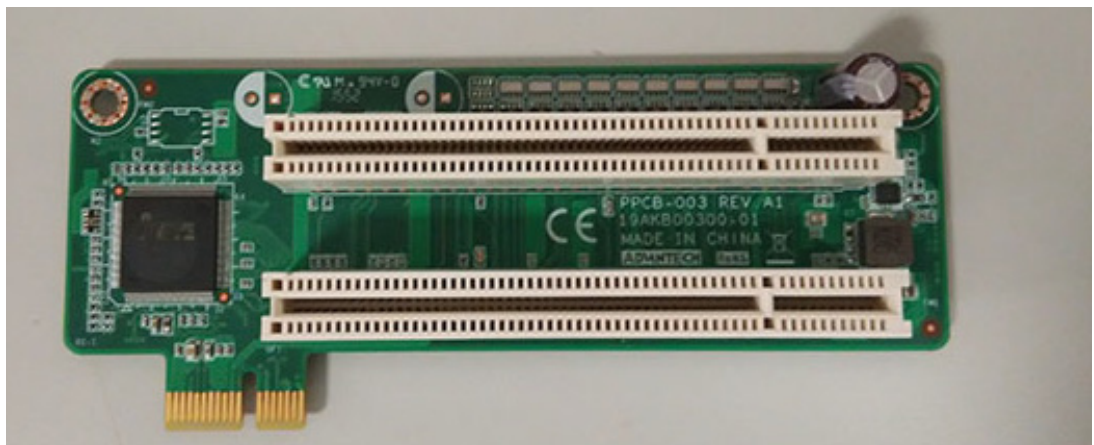

### A.1.2 PPCB-006 PCIe x4 Riser Card

The total current load provided by the PPC-6151C/6171C/6191C PCI slot does not exceed 25 W. Additional details are provided below.

+12 V	2.1A
+3.3 V	3A
+3.3 VSB	0.375A



### A.1.3 EAMB-BE02 2 x PCIe x 1 Riser Card

The total current load provided by the PPC-6151C/6171C/6191C PCIe slot does not exceed 25 W. Additional details are provided below.

+12 V	2.1A
+3.3 V	3A
+3.3 VSB	0.375A



#### A.1.4 EAMB-BE03 1 x PCIe x 1+1 x PCI Riser Card

The total current load provided by the PPC-6151C/6171C/6191C PCIe and PCI slot does not exceed 25 W. Additional details are provided below.

-12 V	0.1A
+12 V	1.0A
+5 V	2A
+3.3 V	2.5A
+3.3 VSB	0.25A

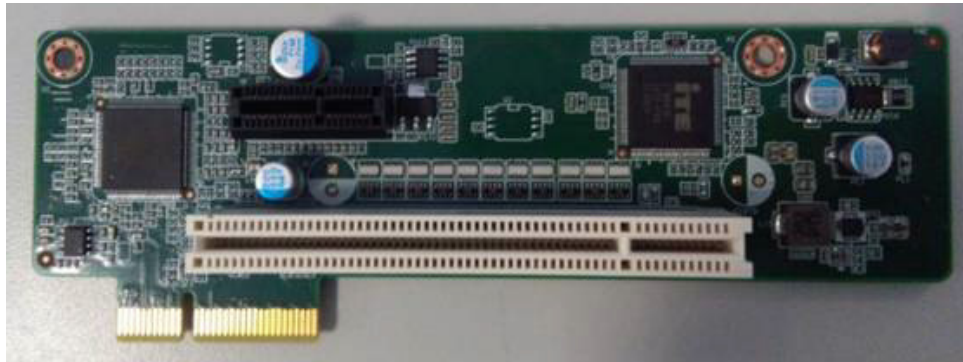

**Note!** The dimensions of the PCI and PCIe cards can not exceed 178 x 107 x 40 (L x W x H).



# Appendix **B**

BSMI ROHS

## B.1 BSMI ROHS

設備名稱 Equipment name	電腦	型號 (型式) Designation (Type)	PPC-6151C/6171C/6191C Series (系列型號參見說明書)			
單元 Unit	限用物質及其化學符號 Restricted substances and their chemical symbols					
	鉛 Lead (Pb)	汞 Mercury (Hg)	鎘 Cadmium (Cd)	六價鉻 Hexavalent chromium (Cr <sup>+6</sup> )	多溴聯苯 Polybrominated biphenyls (PBB)	多溴二苯醚 Polybrominated diphenyl ethers (PBDE)
電路板	—	○	○	○	○	○
液晶面板	—	○	○	○	○	○
觸碰模組	—	○	○	○	○	○
內外殼 (外殼、內部框架 ... 等)	—	○	○	○	○	○
其它固定組件 (螺絲、夾具、卡筍)	—	○	○	○	○	○
配件 (信號線、電源線、連接線、傳輸線 ... 等)	○	○	○	○	○	○
電源供應器	—	○	—	○	○	○
散熱模組 (風扇)	—	○	○	○	○	○
備考 1. “超出 0.1 wt %” 及 “超出 0.01 wt %” 係指限用物質之百分比含量超出百分比含量基準值。 Note 1. “Exceeding 0.1 wt %” and “exceeding 0.01 wt %” indicate that the content of the restricted substance exceeds the defined concentration limit.  備考 2. “○” 係指該項限用物質之百分比含量未超出百分比含量基準值。 Note 2. “○” indicates that the content of the restricted substance does not exceed the defined concentration limit.  備考 3. “—” 係指該項限用物質為排除項目。 Note 3. “-” indicates that the restricted substance is not present in the product.						

## B.2 BSMI 警語及注意事項

警語：使用過度恐傷害視力。

注意事項：

- 1) 使用 30 分鐘請休息 10 分鐘。
- 2) 未滿 2 歲幼兒不看熒幕，2 歲以上每天看熒幕不要超過 1 小時。

# Appendix **C**

China ROHS

## C.1 China ROHS

Dear Customer,

Thank you for choosing this Advantech product. However, to comply with China's electronic industry standard SJ/T11364, which necessitates listing for restricted use the hazardous substances in electrical and electronic products, this chapter describes the product's environmental impact/protection.

(Please disregard this notice if the product is not to be sold/installed in China.)

Model Name	PPC-6151C/6171C/6191C Series					
Substance	Name and concentration of hazardous substances contained in product					
	Lead (Pb)	Hydrargyrum (Hg)	Cadmium (Cd)	Hexavalent Chrome (Cr(VI))	Polybrominated Biphenyls (PBB)	Polybrominated Diphenyl Ethers (PBDE)
Power supply	X	O	O	O	O	O
Monitor + LCD kit	X	O	O	O	O	O
Mechanical parts	X	O	O	O	O	O
Electronic parts and components	X	O	O	O	O	O

"O" indicates that the concentration of the hazardous substance in all homogeneous materials of the component complies with the limits of the GB/T 26572 standard.

"X" indicates that the concentration of the hazardous substance in at least one homogeneous materials of the component exceeds the limits of the GB/T 26572 standard.

Enterprise statements: (for those exceeding the standard)

Content:

The Environmental Protection Use Period (EPUP) typically marked on the product label indicates that during the specified period, under normal operation, the hazardous substances should not leak out or deviate. Thus, product use should not result in substantial environmental pollution, personal injury, or property loss. However, do not confuse the EPUP as the warranty date.

The products attached to the pollution control mark can be recycled; they must also not be discarded at will.





## [www.advantech.com](http://www.advantech.com)

Please verify specifications before quoting. This guide is intended for reference purposes only.

All product specifications are subject to change without notice.

No part of this publication may be reproduced in any form or by any means, such as electronically, by photocopying, recording, or otherwise, without prior written permission from the publisher.

All brand and product names are trademarks or registered trademarks of their respective companies.

© Advantech Co., Ltd. 2018